

Asbestos: The licensed contractors' guide



This is a free-to-download, web-friendly version of HSG247 (First edition, published 2006). This version has been adapted for online use from HSE's current printed version.

You can buy the book at www.hsebooks.co.uk and most good bookshops.

ISBN 978 0 7176 2874 2
Price £14.50

This book replaces most earlier HSE guidance on licensed asbestos removal work. It is aimed at businesses holding a licence to work with asbestos, either repairing or removing asbestos-containing materials (ACMs), supervising such work, holding an ancillary licence or providing training on asbestos. Employers who carry out work with asbestos insulation, asbestos coating, and asbestos insulating board using their own employees on their own premises, who are exempted from the requirement to hold a licence, also need this guidance. It will also be useful to people awarding contracts for such work or who have other asbestos management duties.

The guidance is split into eight chapters, covering different aspects of licensed work with ACMs. It provides an overview of asbestos and its health effects, the law and how to work safely with asbestos.

© *Crown copyright 2006*

First published 2006

ISBN 978 0 7176 2874 2

All rights reserved. No part of this publication may be reproduced, stored in a retrieval system, or transmitted in any form or by any means (electronic, mechanical, photocopying, recording or otherwise) without the prior written permission of the copyright owner.

Applications for reproduction should be made in writing to:
The Office of Public Sector Information, Information Policy Team,
Kew, Richmond, Surrey TW9 4DU or e-mail: licensing@opsi.gov.uk

This guidance is issued by the Health and Safety Executive. Following the guidance is not compulsory and you are free to take other action. But if you do follow the guidance you will normally be doing enough to comply with the law. Health and safety inspectors seek to secure compliance with the law and may refer to this guidance as illustrating good practice.

Contents

List of abbreviations	4
Working with ACMS: Guidance map	5
Chapter 1 An introduction to working with asbestos-containing materials (ACMs)	7
Chapter 2 Licences for work with ACMS	28
Chapter 3 Risk assessments, plans of work and notifications for work with ACMS	38
Chapter 4 Training for employees, supervisors and others working with ACMS	54
Chapter 5 PPE for work with ACMS	75
Chapter 6 Enclosures for work with ACMS	87
Chapter 7 Controlled techniques for the removal and repair of ACMS, including waste disposal	111
Chapter 8 Decontamination	156
References and further information	178

List of abbreviations

ACAD	Asbestos Control and Abatement Division (see Appendix 1.1)
ACOP	Approved Code of Practice
ACM	Asbestos-containing material
AIB	Asbestos insulating board
ALG	Asbestos liaison group
ALH	Ancillary license holder
ALPI	Asbestos Licensing Principal Inspector
ALU	Asbestos Licensing Unit
ARCA	Asbestos Removal Contractors Association (see Appendix 1.1)
ATAC	Asbestos Testing and Consulting (see Appendix 1.1)
ASLIC	Asbestos Licensing Regulations 1983
BA	Breathing apparatus
BOHS	British Occupational Hygiene Society (see Appendix 1.1)
CABA	Compressed airline breathing apparatus
CAWR	Control of Asbestos at Work Regulations 2002
CDG	Carriage of Dangerous Goods and Use of Transportable Pressure Receptacles Regulations 2004
CDM	Construction (Design and Management) Regulations 1994
COSHH	Control of Substances Hazardous to Health Regulations 2002 (as amended)
CSCS	Construction Skills Certification scheme
DCU	Decontamination unit (also called 'Hygiene facilities' and 'Hygiene unit')
DOP	Diocetyl phthalate (test)
EA	Environment Agency
EMAS	Employment Medical Advisory Service
HSE	Health and Safety Executive
HSWA	The Health and Safety at Work etc Act 1974
IEE	Institution of Electrical Engineers
LARC	Licensed asbestos removal contractor
LEV	Local exhaust ventilation
LPG	Liquid petroleum gas
MCG	Main Contractors Group
NPU	Negative pressure unit
NVQ	National Vocational Qualification
PAS	Publicly Available Specification
PF	Protection factor
POW	Plan of work
PPE	Personal protective equipment
PVA	Polyvinyl acetate
PVC	Polyvinyl chloride
RA	Risk assessment
RCD	Residual current device
RPE	Respiratory protective equipment
SCBA	Self-contained breathing apparatus
SEPA	Scottish Environment Protection Agency
SLH	Supervisory license holder
TNA	Training needs analysis
TWA	Time weighted average
UKAS	United Kingdom Accreditation Service

Working with ACMS: Guidance map

This 'Guidance map' provides a quick reference guide to specific topics and key issues in this guide. The items are identified by paragraph numbers.

Planning for asbestos removal work

Topic	Key issues	Reference	
Licence to work with asbestos	When is a licence required?	Paras 2.2-2.4	
	Types of licences	Paras 2.7-2.10	
	How to obtain a licence	Paras 2.11-2.19	
	Enforcement	Paras 2.20-2.23	
Asbestos removal workers	Hiring of employees	Paras 2.25-2.34	
	Consultation with employees	Paras 1.8-1.11	
	Training	Paras 4.1-4.41 and Appendices 4.1-4.4	
	Medical surveillance	Paras 1.47-1.57	
	Personal exposure monitoring	Paras 1.24-1.31	
	Respiratory protective equipment	Selection	Paras 5.7-5.13
		Fit testing	Paras 5.14-5.20
		Care and maintenance	Paras 5.21-5.24
	Coveralls	Selection and use	Paras 5.30-5.36
Laundrying		Paras 8.43-8.46	
Planning for asbestos work	Risk assessments	Paras 3.4-3.15	
	Plan of work	Paras 3.16-3.31	
	Notifications/waivers	Paras 3.32-3.44	
	Site preparation	Paras 6.27-6.29	
	Paperwork required on site	Para 3.45	
	Standard of equipment	Box 7.1	
Enclosures	Enclosures: When required	Paras 6.5-6.10	
	Construction	Paras 6.30-6.40	
	Design	Paras 6.13-6.26	
	Site preparation and pre-clean	Paras 6.27-6.29	
	Negative pressure units	Paras 6.41-6.47	
	Testing and monitoring	Paras 6.48-6.59	
	Smoke tests	Paras 6.50-6.52	
	Viewing panels	Para 6.23	
	Air monitoring	Para 6.56	
	Dismantling and disposal	Paras 6.60-6.67	
	Emergency procedures	Paras 6.68-6.70	
Asbestos removal/repair	Pre-cleaning	Paras 6.27-6.28	
	Stripping techniques	Paras 7.6-7.67	
	Cleaning and waste disposal	Paras 7.87-7.101	
	Four-stage clearance	Paras 7.102-7.146	

Decontamination	Types of decontamination unit	Paras 8.22-8.27
	Design criteria for decontamination units	Appendix 8.1
	Procedures	Paras 8.4-8.21 and Figures 8.8-8.12
	Decontamination unit services	Para 8.28-8.36
	Maintenance and cleaning	Paras 8.37-8.42
	Showering and laundering	Paras 8.43-8.47
	Clearance of decontamination unit	Paras 7.146-7.148

Chapter 1: An introduction to working with asbestos-containing materials (ACMs)



Summary

- Asbestos exposure causes severe and fatal diseases.
- Only work on asbestos if absolutely necessary.
- Asbestos work should be strictly controlled and comply with the legislation.
- Poorly controlled work will produce very high fibre levels.
- Asbestos medical examinations are required when exposure exceeds the action level for asbestos fibres.

Contents

Introduction 9

- About this guidance 9
- Who is the guidance for? 10
- How to use this guidance 10
- Consulting employees 10

Health effects and exposure 11

- What are asbestos diseases? 11
- Working practices and exposure 13
- Air monitoring 14

Legal requirements 16

- The Control of Asbestos at Work Regulations 2002 16
- The Asbestos (Licensing) Regulations 1983 (as amended) 18

Management of asbestos 18

- Is asbestos removal necessary? 18

Medical examination of asbestos removal workers under CAWR 2002 19

- Status of the medical examination and certificate of examination 19
- Risk assessment of the work conditions 19
- When is a medical required? 20
- How often is the medical examination carried out? 20
- The purpose of the examination 20
- Who carries out the medical examination? 20
- The content of the medical examination 21
- Certificate of examination 21

Appendix 1.1 Materials identified as containing asbestos 22

Appendix 1.2 Sprayed asbestos coatings and pipe and vessel insulation in poor condition 23

Appendix 1.3 AIB and insulating blocks in poor condition 24

Appendix 1.4 Other asbestos materials in poor condition 25

Appendix 1.5 Further information 26

Introduction

About this guidance

1.1 This guidance publication covers work with asbestos, which requires a licence under the *Asbestos (Licensing) Regulations 1983 (as amended)*.¹ HSE guidance on non-licensed asbestos work is contained in other publications, *Asbestos essentials task manual: Task guidance sheets for the building maintenance and allied trades*² and *Working with asbestos cement*.³ This licensed contractors' guidance is split into eight chapters, covering in detail, different aspects of licensed work with asbestos-containing materials (ACMs). These chapters are:

Chapter 1: An introduction to working with ACMs (this chapter)

Chapter 2: Licences for work with ACMs

Chapter 3: Risk assessments, plans of work and notifications for work with ACMs

Chapter 4: Training for employees, supervisors and others working with ACMs

Chapter 5: PPE for work with ACMs

Chapter 6: Enclosures for work with ACMs

Chapter 7: Controlled techniques for the removal and repair of ACMs, including waste disposal

Chapter 8: Decontamination

Box 1.1 Key facts about asbestos

- Asbestos-related diseases kill more people than any other single work-related illness.
- Asbestos-related diseases can take 15-60 years to develop and there is no cure.
- Asbestos-related diseases are currently responsible for more than 4000 deaths a year in the UK and the number is still increasing.
- ACMs in good condition and left undisturbed cannot cause ill health.
- The greater the disturbance of ACMs (see Figure 1.1) and the longer the duration, the greater the risk to health.
- Effective control of exposure can only be achieved if techniques that minimise fibre generation have been used, in particular wet stripping.
- Power-assisted respirators provide insufficient protection when removal is uncontrolled, eg during dry stripping.

1.2 This introduction covers the general principles of asbestos and its licensed removal. It provides an overview of asbestos and its health effects, the law and how to work safely with asbestos.

1.3 This guidance replaces and consolidates into one document, most HSE guidance on licensed asbestos removal work. The publications replaced by this document are:

- *Controlled asbestos stripping techniques for work requiring a licence* (HSG189/1)
- *Selection of suitable respiratory protective equipment for work with asbestos* (INDG288(rev1))



Figure 1.1 Asbestos fibres being released from lagging

- *The provision, use and maintenance of hygiene facilities for work with asbestos insulation, asbestos coating and asbestos insulating board (EH47 (Third edition))*
- *Training operatives and supervisors for work with asbestos insulation, asbestos coating and asbestos insulating board (EH50)*
- *Enclosures provided for work with asbestos insulation, coatings and insulating board (EH51)*

Who is the guidance for?

1.4 Any business holding a licence to work with asbestos, eg either repairing or removing ACMs, supervising such work, carrying out ancillary activities, supplying labour or who provide training on asbestos must read this guidance. It is also essential for employers carrying out work with asbestos insulation, asbestos coating, and asbestos insulating board (AIB) using their own employees on their own premises, who are exempted from the requirement to hold a licence (see paragraph 2.4). It may also be beneficial to those who award contracts for such work or have other asbestos management duties.

How to use this guidance

1.5 This guidance should be used as a reference, covering all aspects of licensed work with ACMs. Each of the chapters covers a broad topic area, eg training, and has its own contents list. You can go direct to the chapter you need and use the contents list to navigate that chapter. Where appendices are used for a particular topic, these are kept within the relevant chapter.

1.6 This introductory chapter also contains an overview of the complete process, from licence application through to waste disposal. This overview provides references for all topics, allowing you to navigate easily to specific topics, eg the four-stage clearance procedure. This overview also acts as a quick reference, showing key issues at a glance.

1.7 If you still need help after reading this guidance, Appendix 1.5 contains details of organisations that may be able to provide further advice and expertise.

Consulting employees

1.8 Proper consultation with those who do the work is crucial to help raise awareness of the importance of health and safety. It can make a significant contribution to creating and maintaining a safe and healthy working environment and an effective health and safety culture. In turn this can benefit the business by making it more efficient by reducing the number of accidents and the incidents of work-related ill health.

Involving operatives in decision-making can improve the quality of the job and reduce exposures

1.9 It is important that employees and employee or safety representatives are involved in the assessment and planning process. Employees will provide more accurate information on the actual work methods used and on the feasibility of new proposals. For example, if proposed work methods are difficult or cumbersome, employees may take short cuts that lead to a deterioration in control. Setting unrealistic timescales for contracts may also result in workers taking less care when working with asbestos. Employees generally have greater acceptance of work methods if they have been part of the decision-making process.

1.10 It is particularly important that the wearers of respiratory protective equipment (RPE) are involved in the selection process and, where practicable, are provided with a choice of suitable equipment. This helps to ensure it is suited

to them and increases the chances that they will accept the RPE and wear it correctly.

1.11 Safety representatives, where appointed by recognised trade unions under the Safety Representatives and Safety Committees Regulations 1977,⁴ must be consulted. Safety representatives can play a crucial role in health and safety in the workplace. They can bring ideas and experiences from outside the employer's organisation (eg as a result of trade union training). They also form a link between the workers and management. The presence of safety representatives in the workplace has been shown to cut the major accident rate by more than 50%. Other employees not covered by such representatives must be consulted, either directly or indirectly via elected representatives of employee safety, according to the Health and Safety (Consultation with Employees) Regulations 1996.⁵ This will allow employees or their representatives to help develop suitable and adequate control measures. More information on employers' duties under these regulations is contained in the free HSE leaflet *Consulting employees on health and safety: A guide to the law*.⁶

Health effects and exposure

What are asbestos diseases?

1.12 Breathing in asbestos fibres can lead to asbestos-related diseases, which kill more people than any other single work-related illness. The diseases can take many years to develop - so you and your employees will not be immediately aware of a change in someone's health after breathing in asbestos.

1.13 Asbestos can cause two main types of damage in humans: cancer, eg mesothelioma or lung cancer; and fibrous thickening of the lung, asbestosis. Other diseases, such as pleural plaques, are less serious as they are not disabling. Mesothelioma and lung cancer are severely disabling and most result in death. Severe asbestosis can contribute to death. Figure 1.2 shows normal healthy lung tissues. Figures 1.3, 1.4 and 1.5 show lung tissue from lungs of workers overexposed to asbestos. These conditions, which are described below, can be prevented by good working practices as outlined in this guidance.

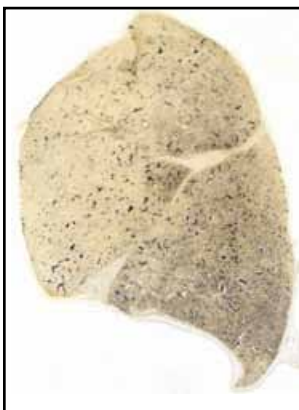

Figure 1.2 Normal lung



Figure 1.3 Heavy exposure to asbestos



Figure 1.4 Lung cancer



Figure 1.5 Mesothelioma due to asbestos exposure

Asbestos-related diseases kill more people than any other single work-related illness

There is no cure for asbestos-related diseases

What is asbestosis?

1.14 Asbestosis is a scarring of the lung tissue which restricts breathing, leading to decreased lung volume and increased resistance in the airways. It is a slowly progressive disease with a latency period dependent on the magnitude of exposure.

What is mesothelioma?

1.15 Mesothelioma is a cancer of the cells that make up the lining around the outside of the lungs and inside of the ribs (pleura), or around the abdominal organs (peritoneum). By the time it is diagnosed, it is almost always fatal. Similar to other asbestos-related diseases, mesothelioma usually has a long latency period averaging 30-40 years. However there are cases where the latency period has been much shorter (around 15 years). There is no known safe threshold of exposure, therefore as the frequency, duration and level of exposure increases, so does the risk of developing mesothelioma.

What is lung cancer?

1.16 Lung cancer is a malignant tumour of the lungs' air passages. The tumour grows through surrounding tissue, invading and often obstructing air passages. The time between exposure to asbestos and the occurrence of lung cancer is on average 20-30 years. There is a synergistic effect between smoking and asbestos exposure. If you smoke and are exposed to asbestos, your risk of developing lung cancer is greatly increased.

Exposure to asbestos and smoking multiplies the risk of developing lung cancer

What are the symptoms?

1.17 Each of these asbestos-related diseases can only be diagnosed through medical examinations and tests. Exposure to asbestos does not mean that these diseases will develop. However, the greater the exposure, the greater the risk of contracting them.

1.18 The symptoms of asbestos-related diseases will usually not become apparent for several decades after exposure. They may include:

- shortness of breath;
- a cough or a change in cough pattern;
- blood in the sputum (fluid) coughed up from the lungs;
- pain in the chest or abdomen;
- difficulty in swallowing or prolonged hoarseness; and/or
- significant weight loss.

Figure 1.6 Controlled removal of asbestos



1.19 Once the asbestos-related disease has been diagnosed, the individual is left with the prospect of a debilitating impact on their health or eventual death. Therefore exposures should always be prevented or minimised to the lowest level reasonably practicable to reduce the risk of ill health later in life.

Reduce exposures now to prevent ill health in the future

Figure 1.7 Uncontrolled
removal of asbestos



Asbestos should only be worked on if absolutely necessary

Uncontrolled removal of asbestos costs lives

Using controlled methods of removal saves lives

Working practices and exposure

1.20 There are three main types of asbestos which have been commonly used:

- crocidolite ('blue');
- amosite ('brown');
- chrysotile ('white').

1.21 All types of asbestos are dangerous but crocidolite and amosite asbestos are known to be more hazardous than chrysotile. The asbestos types are often referred to by their colour. But, it is very difficult to identify them by colour. Colour and appearance can be affected in many ways, including by heat and chemicals, mixing with other substances and through painting or coating.

1.22 Although asbestos is a hazardous material, it can only pose a risk to health if the asbestos fibres become airborne and are then inhaled. ACMs only release fibres into the air when they are disturbed. Also, the greater the disturbance of the ACM during removal, the greater the risk to health. Controlled stripping techniques reduce exposure and therefore the risk of ill health and death (see Figures 1.6 and 1.7). Factors affecting exposure are listed in Box 1.2.

1.23 The number of asbestos fibres in air is affected by many factors. An estimate of the expected concentration of asbestos fibres in air can be made by considering:

- the type of asbestos (crocidolite and amosite are more friable than chrysotile);
- the asbestos product (sprayed coating and lagging are more friable and loose and crumbly than others);
- how the material will be worked on (ie type of tools);
- how roughly the material will need to be treated to do the job;
- how much of it will be worked on;
- how long it will be worked on;
- how effective the control measures at source are in reducing the spread of dust and concentrations of asbestos fibres in air;
- other available information (eg past exposure monitoring records for similar circumstances; information in Tables 1.1 and 1.2);
- past experience and knowledge which are relevant to the work in question; and
- an allowance for short-term unexpected high exposures.

RPE should be used to complement controlled stripping techniques and not in place of them. Uncontrolled removal of asbestos (see paragraph 7.68) will generate airborne fibre concentrations beyond the protection provided by any power-assisted respirator

Box 1.2 Some indicators of high exposure/poor control (this list is not exhaustive)

Work methods

- During removal, dry patches of insulation are found.
- Material in asbestos waste sacks is not doughy, but hard and crumbles when squeezed through the bag.
- Excessive breakage to AIB sheets.
- The inner surface of the viewing panel is dusty.
- Heavily laden pre-filter on the negative pressure unit (NPU).
- Excessive dust/debris on high level surfaces.
- Excessive loose waste stored in the enclosure.
- Poor standard of equipment on site, (eg non-adjustable wet stripping needles).
- Evidence of equipment used incorrectly (eg decontamination unit (DCU) not connected, insufficient wetting fluid).

Workers

- Workers with facial stubble (where face fit is important).
- Evidence of contamination on transiting workers.
- Evidence of contamination on transit/waste routes.
- Evidence of contamination in the DCU.
- Decontamination time too quick.

Enclosure integrity

- Enclosure sheeting shows little sign of negative pressure.
- Sheeting in poor state (holes, tape lifting etc).
- Airlocks in poor state (flaps incorrectly positioned, taped up).
- No or insufficient inward movement of air.
- Poor set up of controls (eg NPU) next to the airlocks, causing 'short-circuiting' of air.
- Unweighted airlock flaps.
- Transit airlock and baglock open at same time.

Air monitoring

1.24 Regulation 18 of the Control of Asbestos at Work Regulations 2002 (CAWR)⁷ requires the measurement of employee exposure at regular intervals and where a change occurs that may affect that exposure. This air monitoring is required to show:

- that control measures (eg wet stripping) are effective and being properly used; and
- that the RPE worn is sufficient to provide adequate protection (ie in addition to primary control measures).

1.25 A strategy should be developed to meet the monitoring purpose identified in paragraph 1.24. The monitoring strategy should also ensure that a representative range of jobs and work methods are examined. Occupational exposures can vary from day to day and even throughout a shift. So, the strategy should take account of the range of circumstances and conditions that can occur, including different ACMs, work methods, work areas, work duration etc. Air sampling results should be used to inform and modify the control arrangements, as necessary.

1.26 The air monitoring data should be used to establish employee exposure records. Monitoring is not required for every job. Sampling data from previous similar jobs can be used to judge the effectiveness of controls and to decide whether action levels or control limits are likely to be exceeded. But, where there is doubt about the expected exposure concentration, the exposure will have to be confirmed by air monitoring.

1.27 Monitoring should be carried out using a method approved by the Health and Safety Commission (eg using methodology described in *Asbestos: The analysts' guide for sampling, analysis and clearance procedures*).⁸ If there is doubt about assessing employees' expected exposure to asbestos fibres, seek help from an occupational hygienist or a specialist laboratory. To carry out asbestos-related sampling and analysis, laboratories must be accredited to ISO 17025 by a recognised accreditation body, eg UKAS (the UK Accreditation Service).

1.28 Tables 1.1 and 1.2 provide information on fibre concentrations likely to be experienced in a range of jobs. The data is only a guide and is not a substitute for carrying out a proper assessment of the likely exposure concentrations. The circumstances of each job can vary widely so an individual assessment should be carried out.

1.29 It is possible to obtain exposures lower than those quoted for controlled stripping techniques. Specialist contractors should therefore not take these fibre concentrations as representing the lowest reasonably practicable, but view them as illustrating how exposures can be reduced. Contractors should therefore always strive to reduce exposure to as low as reasonably practicable.

Table 1.1 Well-controlled work with ACMs

Job	Likely fibre concentrations (fibre/ml)
Controlled wet stripping using manual tools	up to 1 (unless a dry patch is hit or lagging becomes detached)
Careful removal of whole AIB	up to 3
Drilling AIB with vacuum trace - local exhaust ventilation (LEV), or shadow vacuuming (note drilling holes in asbestos should be avoided where possible)	up to 1

Good practice

Table 1.2 Poorly controlled work with ACMs

Job	Likely fibre concentrations (fibre/ml)
Stripping pipe or vessel lagging – partially wetted or dry areas present	up to 100
Stripping sprayed coatings – partially wetted or dry areas present	around 1000
Drilling AIB without vacuum trace	up to 10
Reciprocating power sawing AIB	up to 20
Hand sawing AIB	5-10

Bad practice

Measurements have shown that, where controlled stripping techniques have been used but not correctly applied, they can lead to high airborne fibre concentrations. Poor wetting is often little better than uncontrolled dry stripping

1.30 Other reasons for carrying out air monitoring include:

- stage 3 of the four-stage clearance procedure (see paragraph 7.132);
- leak sampling to check the ongoing integrity of the enclosure (see paragraph 6.56);
- reassurance air sampling after removal work has been completed.

1.31 Further details on air monitoring are provided in *Asbestos: The analysts' guide for sampling, analysis and clearance procedures*.⁸

Legal requirements

1.32 There are several sets of health and safety legislation that directly or indirectly place duties on employers in relation to asbestos. The main pieces of general legislation are listed below:

- **The Health and Safety at Work etc Act 1974⁹ (HSWA) (Section 2)** requires an employer to conduct their work in such a way that their employees will not be exposed to health and safety risks, and to provide information to other people about their workplace which might affect their health and safety. Section 3 of HSWA contains general duties on employers and the self-employed in respect of people other than their own employees. Section 4 contains general duties for anyone who has control, to any extent, over a workplace.
- **The Management of Health and Safety at Work Regulations 1999¹⁰** require employers and self-employed people to make an assessment of the risks to the health and safety of themselves, their employees, and people not in their employment arising out of or in connection with the conduct of their business and to make appropriate arrangements for protecting those people's health and safety.
- **The Construction (Design and Management) Regulations 1994 (CDM)¹¹** require the client to pass on information about the state or condition of any premises (including the presence of hazardous materials such as asbestos) to the planning supervisor before any work begins and to ensure that the health and safety file is available for inspection by anyone who needs the information.

1.33 There are two sets of specific health and safety regulations that directly apply to work with asbestos. These are:

- The Control of Asbestos at Work Regulations 2002;⁷
- The Asbestos (Licensing) Regulations 1983 (as amended) (ASLIC).¹

The key requirements of these regulations are outlined below.

The Control of Asbestos at Work Regulations 2002

1.34 CAWR applies to all work with asbestos. It requires employers to prevent exposure of employees to asbestos or, where this is not reasonably practicable, to reduce exposure as low as is reasonably practicable. The spread of asbestos should also be prevented. The key to controlling asbestos exposure and spread is through a suitable and sufficient risk assessment (RA). Before starting any work where asbestos is present, CAWR requires an employer to make an assessment of the likely exposure of employees to asbestos and to prepare a plan of work (POW). The assessment and POW should be in writing and should, among other matters,

include details of the steps that need to be taken to meet the requirements of the regulations.

1.35 CAWR also includes requirements on the following:

- a duty to manage asbestos in non-domestic premises;
- notification of work with asbestos;
- provision of information, instruction and training;
- use of control measures;
- maintenance of control measures;
- provision and cleaning of protective clothing;
- arrangements to deal with accidents, incidents and emergencies;
- cleanliness of premises and plant;
- air monitoring;
- health records and medical surveillance.

1.36 The licensed asbestos removal contractor (LARC) may not always need to make a new assessment before each individual job if the work involves similar jobs on a number of sites, eg removing asbestos ceiling tiles from a number of identical or similar offices. But where the work varies significantly from site to site, a new assessment will need to be made for each job.

1.37 More information on the requirements of CAWR can be found in the Approved Code of Practice (ACOP), *Work with asbestos insulation, asbestos coating and asbestos insulating board. Control of Asbestos at Work Regulations 2002. Approved Code of Practice and guidance.*¹²

Control limits and action levels

1.38 CAWR also specifies requirements to limit airborne exposure to asbestos: control limits and action levels. A control limit is that concentration of asbestos in the air (averaged over any continuous four-hour or ten-minute period) above which employees must not be exposed to unless they are wearing suitable RPE. Both the four-hour and ten-minute periods have their own control limits, the values of which vary depending on the type of asbestos present. The control limits are given in Table 1.3 and exposures should be reduced to the lowest level reasonably practicable below them.

1.39 Action levels apply to exposure in the longer term, and are cumulative exposures calculated over any continuous 12-week period. The 12-week period should not be deliberately chosen to avoid exceeding an action level; it should represent a 'worst case' for the work being undertaken. If the exposure of any employee exceeds or is likely to exceed an action level, the regulations in CAWR on notification, designated area and medical surveillance, apply. The action levels are given in Table 1.3. *Asbestos: The analysts' guide for sampling, analysis and clearance procedures*⁸ contains guidance on how to calculate action levels.

Table 1.3 Control limits and action levels for asbestos

Asbestos type	4-hr control limit (f/ml)	10-min control limit (f/ml)	Action level (fibre hrs/ml ²)
Chrysotile alone	0.3	0.9	72
Any other form of asbestos, either alone or in mixtures, including mixtures of chrysotile with any other form of asbestos	0.2	0.6	48

Notes

f/ml - fibres per millilitre of air averaged over any continuous period.

fibre hours/ml - calculated by multiplying the airborne exposure in f/ml by the time in hours for which it lasts to give exposure in fibre hours/ml. Cumulative exposures are calculated by adding together all the individual exposures over any continuous 12-week period.

The Asbestos (Licensing) Regulations 1983 (as amended)

1.40 In Great Britain, work on asbestos insulation, asbestos coating and AIB has, by law, to be carried out by a contractor who holds a licence under ASLIC although there are exceptions, eg where the work is of short duration. Paragraphs 2.2-2.10 provide full details.

1.41 **These exclusions mean that maintenance workers do not need a licence to do minor work, eg installing a light fitting, providing the work is short duration and exposures are unlikely to exceed action levels or control limits. Although a licence is not required, they should have the necessary expertise and the work must comply with CAWR. However, in general terms, good working practices are followed, compliance with CAWR will be achieved. HSE has produced guidance for non-licenced work, *Asbestos essentials*. There are two publications, *Introduction to asbestos essentials: Comprehensive guidance on working with asbestos in the building maintenance and allied trades*;¹³ and *Asbestos essentials task manual: Task guidance sheets for the building maintenance and allied trades*,² both available from HSE Books.**

Management of asbestos

Is asbestos removal necessary?

1.42 Regulation 4 of CAWR places a duty to manage asbestos in non-domestic premises. As part of the management of asbestos, ACMs should be maintained in good condition and only removed if absolutely necessary. ACMs in good condition and left undisturbed will not release fibres into the air and will not cause exposure and spread. Asbestos should not be removed simply because it is there. It may also be possible to avoid disturbance of asbestos during maintenance or building work, eg by routing services through an alternative location.

1.43 The removal of asbestos by its very nature will cause disturbance and spread. Where it is removed, the work must be strictly controlled. Appendices 1.1-1.4 contain flow charts describing the options for the management of ACMs. There are charts for different types of asbestos. The charts work systematically through the options and actions for ACMs, depending on the type and condition of the material.

1.44 Examples where removal will be necessary include:

- before the demolition of a building;
- before maintenance or refurbishment work which may disturb ACMs;
- where ACMs are damaged;
- where ACMs are vulnerable to damage by the normal day-to-day activities in the building;
- where a change in the use of a building may make ACMs more prone to damage.

Asbestos should only be removed if absolutely necessary

1.45 ACMs should remain in place and be included in a building management plan. Small areas of damage can be repaired, the material encapsulated or enclosed by another non-asbestos material.

1.46 Appendices 1.1-1.4 summarise the management decisions and actions to be taken as part of the management process for asbestos in buildings. Further detailed information on managing asbestos in buildings is given in *A comprehensive guide to managing asbestos in premises*.¹⁴

Medical examination of asbestos removal workers under CAWR 2002

Status of the medical examination and certificate of examination

1.47 Under the current CAWR the medical examination is not a fitness for work examination. The certificate of examination only contains the information that an employee has been examined at a certain date (regulation 21, paragraphs 4 a and b). All other statutory medical examinations (for instance for lead, ionising radiation and diving) conclude with a fitness for work judgement. This approach in the CAWR medical examination is unusual and has historical reasons. As a consequence, the medical examination does **not** certify that the employee is necessarily fit for all work conditions that can be present in an asbestos enclosure. This current position may change at the next review of CAWR, due in 2006.

Risk assessment of the work conditions

1.48 The employer has to assess any specific hazards and risks in their RA as required by regulation 3 of the Management of Health and Safety at Work Regulations 1999.¹⁰ Such factors may include working with RPE or working at height with the risk of falling. Depending on the conditions inside the enclosure, for instance when work in hot conditions cannot be avoided, an asbestos enclosure may also become a confined space, as defined in the Confined Spaces Regulations 1997.¹⁵ If that is the case, the competent person carrying out the RA for work in confined spaces may need to consider the suitability of individuals for that work. This may, eg require checking whether the individuals are of a suitable build and stamina. If in doubt, but especially in the case of unavoidable hot work or the necessity to wear breathing apparatus, competent medical advice on an individual's suitability for the work may be needed and therefore an additional fitness for work examination, in addition to the CAWR medical examination, may be required (see *Work with asbestos insulation, asbestos coating and asbestos insulating board. Control of Asbestos at Work Regulations 2002. Approved Code of Practice and guidance*, paragraph 79).¹²

1.49 Considering the fitness for work of the operatives is always good practice, even if the strict definition of a confined space does not apply. In particular, where any medical condition could interfere with the correct use of personal or respiratory protective equipment, an operative is prone to sudden loss of consciousness or

has significant sickness absence, an assessment by a competent person could be needed. Examples of such medical conditions are heart and lung (for instance asthma) diseases, unstable diabetes mellitus, epilepsy, claustrophobia (fear of small spaces), mental conditions or the taking of certain medications. Simple questionnaires, preferably administered by an occupational nurse, can help introduce additional safety with minimal effort. Final judgement on fitness for work in case of detection of medical anomalies should be reserved for an occupational physician with good knowledge of the specific work requirements and work conditions present in an asbestos enclosure.

When is a medical required?

1.50 A medical examination is required when the exposure of an employee could exceed the action level for asbestos fibres. The action level is an amount of fibres per millilitre of air as measured over a 12-week period (see paragraph 1.39). The Regulations currently give different action levels for chrysotile asbestos and other types of asbestos, although in reality, most asbestos removal workers work with all types of asbestos and for simplicity use the control limits/action levels for amosite/crocidolite. Because the action level is measured over a period of time and also depends on the type of asbestos being worked with, the question whether the action level will be exceeded depends on the pattern of work and the RA for each job. The employer is responsible for this RA and therefore also for determining whether the employee might exceed the action limit. Most removal worker exposure will exceed the action level.

How often is the medical examination carried out?

1.51 When work with asbestos starts under conditions that will exceed the action level, employees need to be under medical surveillance. For the purpose of the Regulations it is however sufficient if the employees and the employer have obtained a valid certificate of examination, which is not older than two years, before the work starts. After the first examination the medical examination is repeated at intervals of no longer than two years (or at a shorter interval as decided by the doctor who carries out the examination), for as long as the employee is likely to be exposed over the action level.

The purpose of the examination

1.52 Asbestos in all its forms is a very hazardous material. It can cause serious lung disease such as asbestosis and different forms of lung and other cancers (mainly malignant mesothelioma (see paragraphs 1.12-1.19). From past experience we know that under the current exposure situations the biggest risk to health is still the risk of cancer.

1.53 The medical examination is part of the strict control measures necessary to help ensure that people who work with asbestos do so in a safe way. The main aim of the examination is to advise the **employees** about the potential health risks of asbestos and of their fitness for work. The latter is however not communicated to the employer in the certificate of examination. Although the examination is looking for signs of ill health, possibly linked with asbestos exposure, it is important to know that it may take many years before signs of ill health from past asbestos exposure become detectable by the examination. Therefore the other important purpose of the examination is to provide the employee with the opportunity to speak to a medical doctor about any concerns they may have regarding their work and/or their health.

Who carries out the medical examination?

1.54 Medical examinations under CAWR are carried out either by an employment medical advisor working for HSE or by an appointed doctor. In practice, an appointed doctor will almost always carry out the examination. Appointed doctors are appointed by the Employment Medical Advisory Service (EMAS) of HSE and

act as an agent on behalf of EMAS. EMAS provides guidance for the appointed doctors, as well as conducting regular checks to control the quality of their work and their medical documentation.

The content of the medical examination

1.55 The Regulations require the doctor to perform at least a specific examination of the chest. EMAS guidance will provide the appointed doctor with advice about the content of the examination. Usually the examination will include taking or updating a work history and questions about general health and the health of the lung. The doctor will perform a clinical examination of the chest and look for other signs of respiratory disease as well as carrying out a lung function test. A chest X-ray is not part of the examination on a routine basis. The reason for this is that the doctor is obliged by law to make an assessment of the benefit in each individual case of any chest X-ray examination, bearing in mind that all ionising radiation (X-rays) carry a small health risk. If the doctor has reason to believe that a chest X-ray would be useful on clinical grounds then it may be ordered as part of the examination. It is important to remember that an 'all-clear' chest X-ray does not mean that the current working methods are safe because it takes many years (usually more than 15-20) before a chest X-ray will show any signs of past asbestos exposure.

Certificate of examination

1.56 After the examination the appointed doctor will issue the employee and the employer both with an **original** certificate of examination. This is to reduce the chance of forgery of certificates.

1.57 This certificate only indicates that the examination under the requirements of CAWR has been carried out and includes the date of the examination. It does not certify any fitness to work with asbestos. This is because the appointed doctor is unable under the Regulations to declare someone unfit for work with asbestos. The appointed doctor does however have an obligation to advise the employee if they think the employee is not fit to start work with asbestos or in their opinion should stop working with asbestos. In exceptional circumstances, where someone is clearly a danger to themselves and possibly others, the appointed doctor may consider informing the employer about the employee's condition. Usually the appointed doctor will however ask for informed consent before disclosing any medical in confidence information to the employer.

Appendix 1.1 Materials identified as containing asbestos

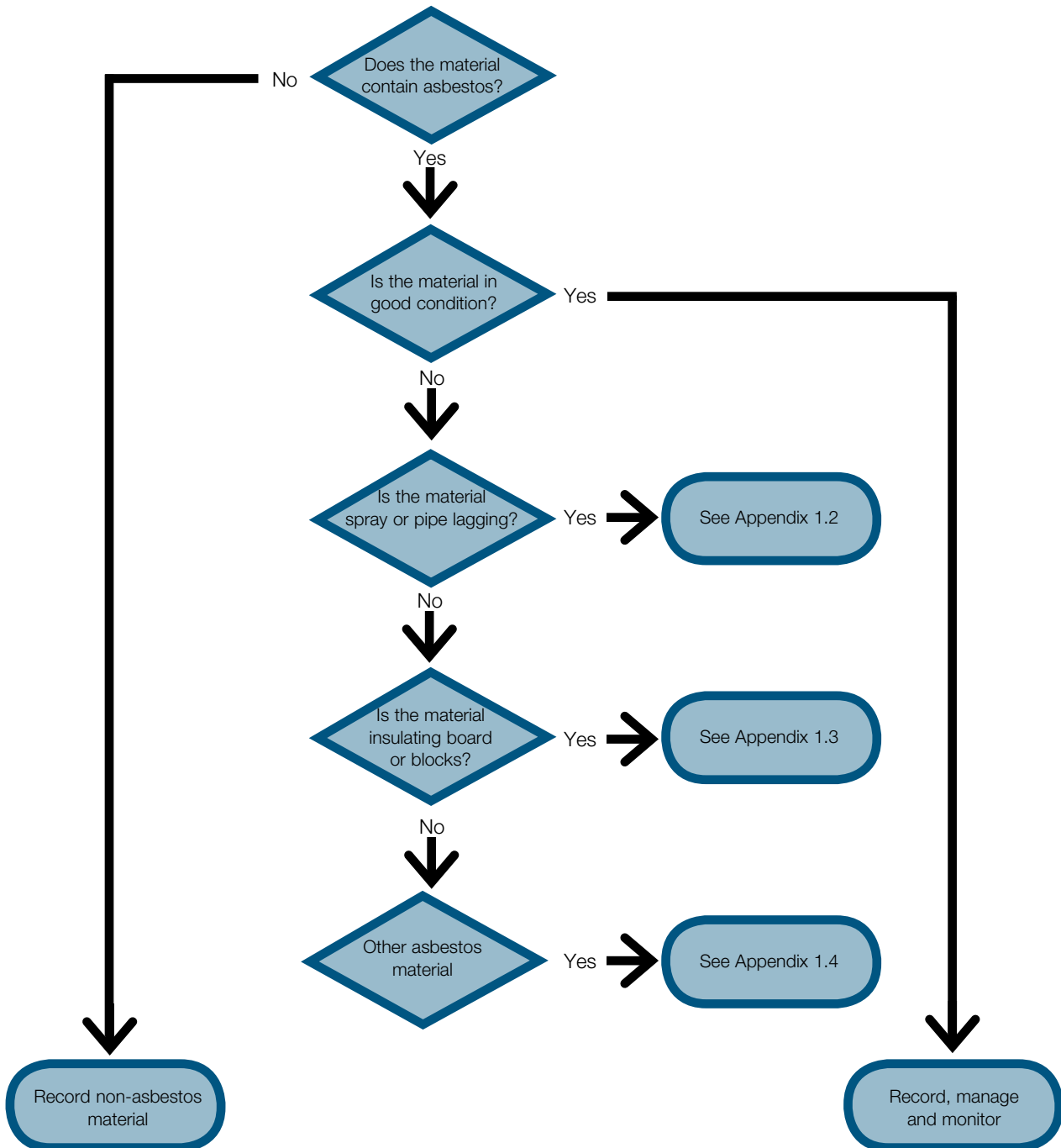

Appendix 1.2 Sprayed asbestos coatings and pipe and vessel insulation in poor condition

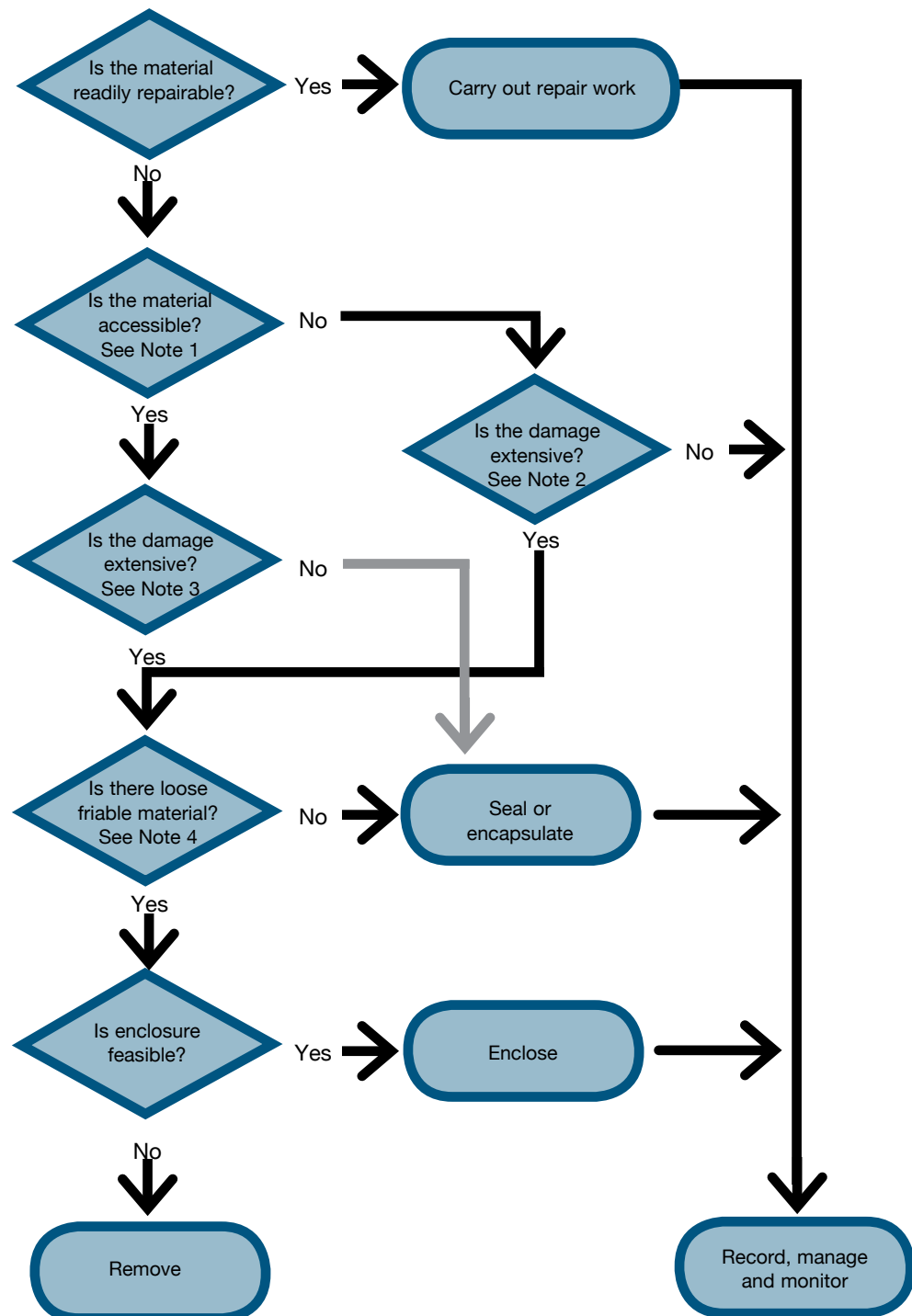

Notes

- 1 Is the material accessible and vulnerable to further accidental or deliberate damage from adjacent repair or maintenance, impact by people, vehicles, objects or vandalism?
- 2 If the damage is slight and the ACM is not easily accessible, remedial work is unlikely to be necessary. The damage should be monitored and your decision reviewed if circumstances change (eg the area becomes accessible)
- 3 If the damage is superficial, eg slight cracking to pipework insulation or deteriorated surface finish, then answer 'no' to this question. If, eg the insulation is starting to come away from the pipework or the spray coating appears to be loose in places, then answer 'yes' to this question. If there is debris on the floor or other surfaces then this will need removing following appropriate precautions.
- 4 The damage may be extensive, but if the material is generally sound without friable material or loose pieces, then sealing/encapsulation may be possible.

Appendix 1.3 AIB and insulating blocks in poor condition

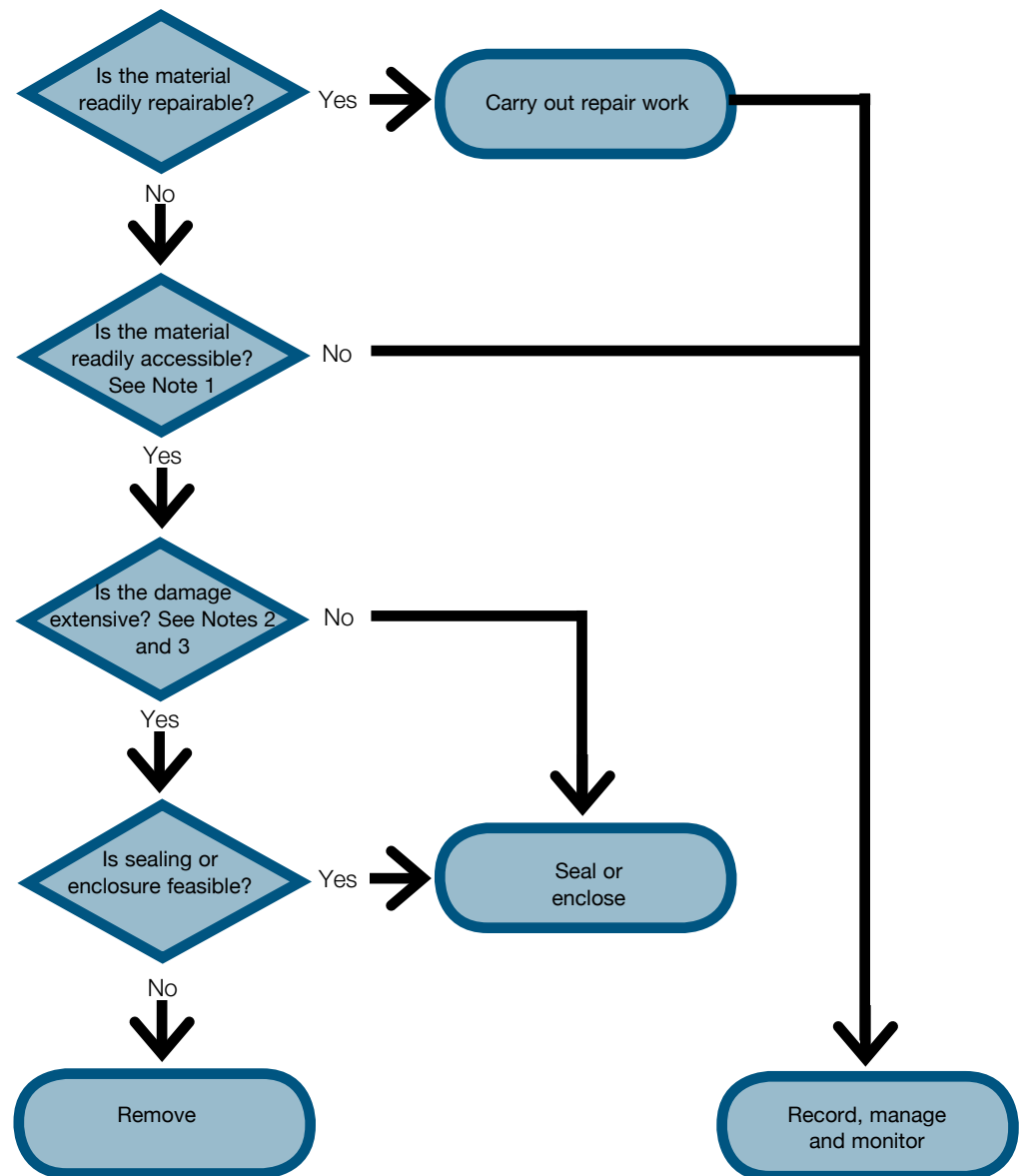

Notes

- 1 Is the material accessible and vulnerable to further accidental or deliberate damage from adjacent repair or maintenance, impact by people, vehicles, objects or vandalism? If the damage is not easily accessible, remedial work may not be necessary. The damage should be monitored and your decision reviewed if circumstances change (eg the area becomes accessible).
- 2 If the damage is superficial, eg slight cracking to pipework insulation or deteriorated surface finish, answer 'no' to this question. If, for example, the insulation is starting to come away from the pipework or the spray coating appears to be loose in places, answer 'yes' to this question.
- 3 If there is debris on the floor or other surfaces, this will need removing following appropriate precautions.

Appendix 1.4 Other asbestos materials in poor condition (read Notes 1 and 2 first)

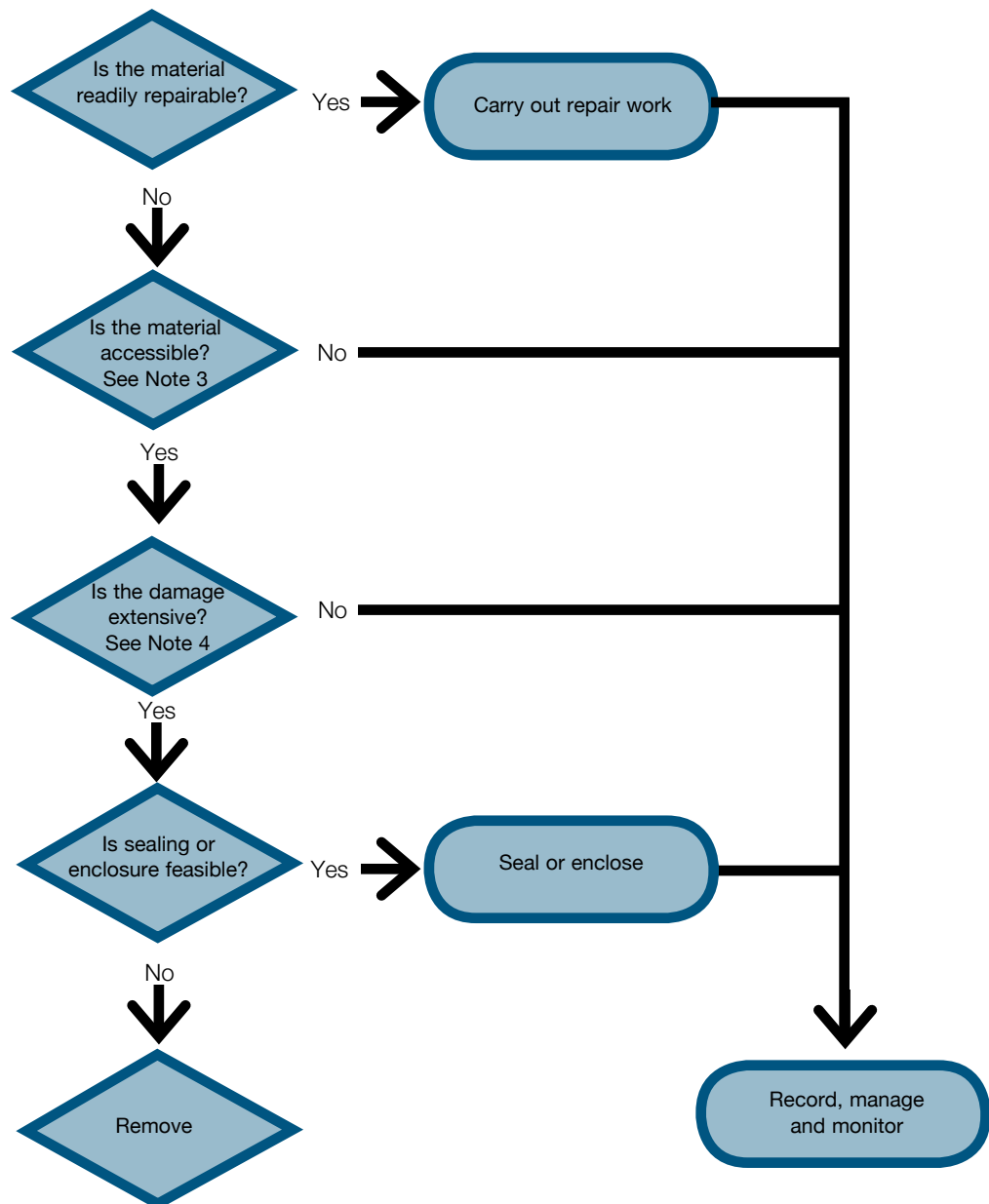

Notes

- 1 This chart covers products not included in Appendices 1.2 and 1.3 such as asbestos cement, textiles, gaskets, ropes and encapsulated products such as vinyl and thermoplastic tiles, roofing felts etc. Materials which are encapsulated in a resilient matrix will have limited ability to release fibres, therefore asbestos in reinforced plastics, vinyls, resins, rubber, mastics, bitumen, paints, flexible plasters and cements have little opportunity to release fibres unless the matrix is removed (eg degraded, dissolved or burnt) or subject to high levels of abrasion (eg use of power tools). Management of these types of materials so maintenance workers do not use abrasive methods and power tools is usually sufficient to minimise airborne asbestos releases. Sealing may be considered if there is evidence of routine wear and abrasion. The flow chart shows you the decisions to consider if remedial action is deemed to be necessary. However, unless the damage is significant or they are in a vulnerable position, urgent remedial action is unlikely to be necessary and you should simply remove these products, following the correct precautions when they come to the end of their useful life, or before refurbishment or demolition.
- 2 Products which are less well encapsulated (eg asbestos textiles and gaskets), will release fibres more readily and use of controlled work methods by maintenance workers and enclosure or sealing to prevent damage may be necessary in some circumstances.
- 3 Is the material accessible and vulnerable to further accidental or deliberate damage from adjacent repair or maintenance, impact by people, vehicles, objects or vandalism?
- 4 If the damage is slight, remedial work is unlikely to be necessary. The damage should be monitored and your decision reviewed if circumstances change (eg the area becomes accessible).

Appendix 1.5 Further information

This guidance will help you to assess and control occupational exposure to asbestos, but you may need to seek advice and expertise from other sources. These include:

- trade associations, who can provide advice on current practice, technological developments etc. For example:
 - ACAD;
 - ARCA;
- your local HSE office or HSE's Infoline;
- your equipment supplier;
- your personal protective equipment (PPE) supplier;
- occupational hygienists/safety consultants can provide advice on the assessment and control of exposure to asbestos. If you decide to employ the services of a consultancy, you should ensure that they are competent to carry out the work. One way to do this is to use one that is a member of BOHS/ ATAC.

ACAD:

Asbestos Control and Abatement Division
TICA House
Allington Way
Yarm Road Business Park
Darlington
Co Durham
DL1 4QB
Tel: 01325 466704
www.tica-acad.co.uk

ARCA:

Asbestos Removal Contractors Association
ARCA House
237 Branston Road
Burton upon Trent
Staffordshire
DE14 3BT
Tel: 01283 531126
www.arcaweb.org.uk

BOHS:

British Occupational Hygiene Society
5/6 Melbourne Business Court
Millennium Way
Pride Park
Derby
DE24 8LZ
Tel: 01332 298101
www.bohs.org

ATAC:

Asbestos Testing and Consulting
237 Branston Road
Burton upon Trent
Staffordshire
DE14 3BT
Tel: 01283 531126
www.arcaweb.org.uk

HSE Infoline:
Tel: 0845 345 0055
Fax: 0845 408 9566
Textphone: 0845 408 9577
e-mail: hse.infoline@natbrit.com

Chapter 2: Licences for work with ACMs

Health and Safety at Work etc. Act 1974
Asbestos (Licensing) Regulations 1987

FOR ALU OFFICIAL USE
File ref No. Expiry date:
Return ASB4 to ALU by

HSE
Health & Safety
Executive

Application for a licence to carry out work with asbestos insulation or asbestos coating or asbestos insulating board

Part A - General Information

1. Name of limited company, public liability partnership, firm or owner (for partnerships in England/Wales include the names in full of all the partners (see note 1))

2. Nature of business. Please describe the main work you undertake (see note 2)

Summary

- A licence is required for work on asbestos, unless one of the exemptions applies.
- There are three categories of work which require a licence: full, supervisory and ancillary.
- Licence application packs can be obtained from HSE's Asbestos Licensing Unit (ALU).
- Strict controls are placed on hiring employees for work with ACMs.

Contents

Introduction 30

Licences for work with ACMs 30

When is a licence required? 30

Types of licence 32

How to obtain a licence 33

Enforcing authority site visits 34

Liaison with the asbestos industry 35

Hiring employees 35

Hiring removal operatives from another company 35

Introduction

2.1 Disturbance of certain types of asbestos products can give rise to significant health risks. Therefore, as part of health and safety legislation, the law requires that work with the most hazardous forms of asbestos can only be carried out by companies who have obtained a licence for such work from HSE (there are minor exceptions to this). This licensing regime is a key component in the arrangements to ensure the highest standards of asbestos control and protection for workers and the public. This chapter explains the licensing system.

Licences for work with ACMs

When is a licence required?

2.2 ASLIC prohibits work with certain types of asbestos materials, namely asbestos insulation, asbestos coating or AIB, except in specific circumstances (see paragraph 2.4), unless it is carried out by an employer or a self-employed person who holds a licence granted by HSE. Under powers delegated from HSE, the ALU may grant a licence for work with these materials if it considers it appropriate to do so.

2.3 Under ASLIC, work with asbestos means work in which asbestos insulation, asbestos coating or AIB is removed, repaired or disturbed and includes work in a supervisory or ancillary capacity (see ASLIC, paragraphs 16-17).¹

2.4 There are three occasions when a licence to work with asbestos insulation, asbestos coating or AIB **is not required**. These are:

- for work of short duration (this is where the total number of hours worked is not longer than one hour in seven consecutive days for any one person and the total time spent by all the workers is no more than two hours, also in seven consecutive days);
- for air monitoring or sample collection to identify asbestos; or
- if you are an employer carrying out the work with your own employees on your own premises (**Note:** in such circumstances notification to the appropriate enforcing authority is required under regulation 5 of ASLIC).

Irrespective of whether the work is licensable or not, any work with asbestos must comply with CAWR

Short duration work

2.5 All companies, whether licensed or not, may carry out work of short duration, provided they possess the necessary expertise. The exemption applies to individual tasks, where the specified time periods in paragraph 2.4 are not exceeded. However, those individuals cannot then do any more unlicensed short duration work for seven days and the employer must be able to show that they have a system of controlling this work, recording times, notifying managers, etc. The time calculation includes:

- any preparatory work, such as sheeting of the floor, segregating the work area, or any other activity involved in preparing the work;
- the actual work on the asbestos; and
- any activities once the actual work on the asbestos has been completed, such as cleaning up.

Products excluded from the licensing regulations

2.6 There are certain asbestos products to which ASLIC does not apply. ASLIC does not apply to:

- asbestos cement (see Figure 2.1), defined as material which is mainly a mixture of cement and asbestos and which when in a dry state has a density greater than 1 tonne per cubic metre. This material is typically found as roofing sheets, gutters, cladding, drainpipes, flues and some soffits;
- articles made of rubber, plastic, resin or bitumen but which also contain asbestos (eg vinyl floor tiles, electric cables and roofing felts); or
- other asbestos products which may be used at high temperature but have no insulation purposes, such as gaskets, washers, ropes and seals.

Figure 2.1 Non-licensable products



Figure 2.2 Removal work



Figure 2.3 Supervisory licence holder checking the integrity of an enclosure

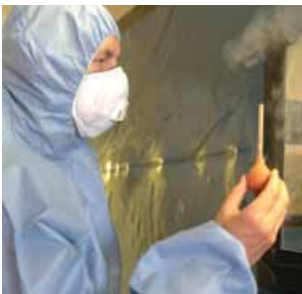

Figure 2.4 Scaffolding work



Types of licence

2.7 There are three categories of work requiring a licence – full repair and removal work, supervising work and ancillary work (but also see paragraph 2.10).

- A **'full'** licence is required to remove, repair or disturb asbestos insulation or asbestos coating or AIB (see Figure 2.2).
- A **'supervisory'** licence is required for those involved in direct supervisory control over asbestos work being undertaken by another licensed contractor (see Figure 2.3). Direct supervisory control is taken to mean where there is direct and immediate influence over current site activities involving any aspect of the work with asbestos, including the equipment and controls being used; how the work is done (methods); how the site is prepared, cleaned up etc; the monitoring of controls (eg inspecting DCUs, changing filters etc); and movement, storage and transfer of waste.
- An **'ancillary'** licence is needed to carry out work associated with the main work of repair, removal or disturbance of asbestos insulation, asbestos coating or AIB.

Examples where an **ancillary** licence is needed include:

- the erection or dismantling of enclosures for licensable asbestos work;
- the maintenance and servicing of certain types of equipment (eg NPUs) on site;
- the erection, altering, maintenance, or dismantling of scaffolding which forms the key part of the framework or the overall support from which an enclosure will be built for licensable asbestos work, or if the scaffolding provides access for work on asbestos (or otherwise) where it is foreseeable that asbestos is likely to be disturbed by the scaffolding activity (see Figure 2.4).

2.8 All licences contain standard conditions and some may have additional conditions. **Supervisory** and **ancillary** licences each contain an additional condition, which limits the work of the licence holder to that activity. The standard conditions are summarised in Box 2.1.

2.9 Licences are usually granted to work with all three forms of licensable asbestos material. Depending on the type of work undertaken this may not be appropriate and the licence will be limited to those licensable asbestos materials the applicant is competent to work with, eg a specific licence for AIB or decorative coating.

2.10 Licences are also granted to organisations who do not undertake work themselves, but act as **'recruitment agencies'**, supplying labour to other licence holders. These licences restrict the activity of the licence holder to hiring out trained and equipped operatives to do work that is supervised and managed by other licence holders.

Box 2.1 Summary of standard licence conditions

1 The licence (or a copy) should be made available to those who need to see it, eg potential clients at tendering, inspectors. A copy of the licence should accompany each notification of asbestos work and a copy should be available on site.

2 The licensee should give written notice (at least 14 days or other agreed period in advance) to the relevant enforcing authority of each asbestos job. The notice should specify:

- the type and likely duration of the work;
- the address of the premises involved;
- the starting date.

The enforcing authority must also be informed in writing immediately if this information changes.

3 The notice of work required by condition 2 shall include:

- a suitable and sufficient written method statement for the work;
- suitable and sufficient written details of the control measures (including RPE and personal protective equipment (PPE)) and decontamination procedures for the asbestos workers.

How to obtain a licence

2.11 For HSE to be able to consider granting a licence, the applicant must:

- intend to do work with asbestos insulation, asbestos coating or AIB (HSE does not grant licences to applicants who do not intend to work with asbestos but who have only applied for 'commercial' reasons);
- have at least one or more competent individual(s) within the organisation, who will have lead responsibility for asbestos work;
- have a written policy and organisational arrangements which will satisfy the requirements of CAWR; and
- be clear about the type of licence (ie full, supervisory or ancillary) that would be appropriate for their business and for which their organisation has the necessary competence.

2.12 An application pack, comprising explanatory notes, an application form FOD ASB1, a list of reading material and a list of training organisations, is available direct from the Asbestos Licensing Unit, Health and Safety Executive, Belford House, 59 Belford Road, Edinburgh EH4 3UE Tel: 0131 247 2135. Existing licence holders are automatically sent an application pack a few months before the expiry of their current licence.

2.13 The FOD ASB1 is a general form for all licence applications. It must be completed and sent to ALU at least 28 days before the date from which the licence is to run, together with the current fee.

2.14 On receipt of the completed application form and fee, the details are checked by ALU and the form is sent to the Asbestos Licensing Principal Inspector (ALPI), based at the applicant's local HSE office. Arrangements are then made for the ALPI or one of their inspectors to assess the applicant's capability to work with asbestos insulation, asbestos coating or AIB.

2.15 Every applicant will be formally assessed on all aspects of managing and

working with ACMs. The assessment will include knowledge of asbestos and asbestos requirements, practical aspects of the work, management policies, systems and record-keeping arrangements.

2.16 A good understanding of the standards expected together with adequate arrangements for meeting these standards is essential for making a successful application. In some cases, an applicant (eg managing director) may not have the **detailed** knowledge of asbestos requirements, as this may have been delegated to other employees within the firm. In such cases, it would be expected that a competent person responsible for asbestos operations within the organisation would be present at the assessment together with a director or partner. If the applicant (and the responsible person, if required) were not fully conversant with these requirements, it would be unlikely that the application would be successful.

2.17 Part of the assessment concentrates on practical matters including training, medical certification, RPE and equipment such as NPUs and DCUs. Whether the application is for a full, supervisory or ancillary licence, the assessment will cover the same topics but to varying degrees. For example, an applicant for an ancillary licence to do scaffolding work associated with asbestos removal, would not be expected to have detailed knowledge of asbestos removal techniques and the equipment requirements for this work.

2.18 Following the assessment, a report is completed by the inspector and is submitted together with recommendations to ALU. Successful applicants are granted a licence either for one year (new applicants are granted a one-year licence) or three years. Most renewal applicants graduate to a three-year licence, but some are renewed for a shorter period. One or two-year renewed licences may be given for the following reasons:

- the applicant's performance has caused concern;
- a failure to maintain competence;
- keeping inadequate records or by allowing training to lapse;
- not having done any work in the previous licence period;
- change of management.

2.19 Unsuccessful applicants are informed by ALU of the reasons for refusing their application and are usually given four months to rectify matters and be reassessed, should they wish to proceed. There is a charge for reassessments.

Enforcing authority site visits

2.20 All licence holders are required as a condition of their licence to notify the enforcing authority (either HSE or the local authority) with details of the proposed work at least 14 days before it is due to start. Separate notification is required for all licensed organisations on the same job.

2.21 This condition gives the enforcing authorities the opportunity to assess the proposals contained in the licence holder's POW, which forms part of the notification, and to inspect the site either before or during the work.

2.22 Licence holders in certain categories are more likely to receive proportionately more site visits from HSE. These categories include:

- new one-year licence holders;
- three-year licence holders whose licence expires in four to six months and who have not been visited in the previous twelve months;
- licence holders whose past performance has given cause for concern;

- licence holders who have proposed a work method which raises concerns (eg proposals to carry out uncontrolled dry stripping, unjustified use of a power tool or to work in close proximity to hot surfaces).

2.23 Reports of inspectors' visits to licensed asbestos work are submitted to ALU, who review the licence holder's performance accordingly. If adverse reports are received, this may result in action being taken against the licence holder, eg their licence may be amended (by having further conditions added or by having the licence term reduced), or they may be refused a licence on application or the licence may be revoked. This may be in addition to any enforcement action that might be taken by the local inspector(s) who carried out the site inspection, eg the inspector may issue a Prohibition Notice on the contractor where site conditions indicate a risk of **serious personal injury** if the work continues without further controls. This is a formal step to stop the work until HSE can be sure the work can proceed safely.

Liaison with the asbestos industry

2.24 In 2000, HSE established an industry liaison forum, the Asbestos Liaison Group (ALG), comprising members from the main asbestos trade associations, trade unions and HSE. ALG provides a forum to promote quality standards, best practice and consistency of approach in relation to control and work with asbestos across Great Britain. It meets regularly and is also responsible for producing jointly prepared guidance notes (ALG memos) to address issues of concern. The memos are available on the HSE website at www.hse.gov.uk/aboutus/meetings/alg/index.htm.

Hiring employees

2.25 From time to time, licence holders may need to hire temporary personnel to supplement labour. In such circumstances, to comply with ASLIC, the licence holder must either recruit directly, or hire personnel from other licence holders (ie another licensed asbestos removal contractor), or from a company with an asbestos licence from HSE to supply labour. Standards of site control should be maintained in such circumstances.

2.26 Organisations in the third category do not undertake work themselves but act as 'recruitment agencies' supplying labour to other licence holders. These licences contain specific conditions restricting the activity of the licence holder to hiring out trained and equipped operatives, who hold current certificates for medical examinations and RPE face-fit testing, to do work that is organised and managed by other licence holders.

Hiring removal operatives from another company

Licence holders who undertake work in their own right and supply labour

2.27 Licence holders may supply their employees (ie operatives) to work under the supervision of other licensed contractors (these employees will not act in a supervisory or management capacity, but see paragraph 2.34). Licence holders' responsibilities in these circumstances are set out in Box 2.2. If the licence holder supplies labour infrequently (eg less than once a month), then they are not required to notify the enforcing authority about this.

2.28 If the licence holder regularly supplies labour (eg at least once a month) then they must inform the Head Office ALPI every three months in arrears. The licence holder will consequently have a further licence condition added regarding hiring.

2.29 Licence holders who hire in labour must record exposure levels for the

period during which the temporary staff have worked for them and provide this information to the licence holder who supplied the labour. The licence holder supplying the labour must ensure that they obtain this information to complete their employees' exposure records, making sure that there are no gaps in the documentation.

Licence holders ('recruitment agencies') who supply labour but undertake no work in their own right

2.30 Organisations who hold a licence to supply labour, but who do not actually undertake work themselves are not permitted to supply personnel to supervise or manage the work being undertaken by other licence holders. The asbestos licensed contractor actually doing the work is responsible for supervising and managing it.

2.31 Licence holders in this category are required to notify details of their employees, their hire contacts etc, as specified in their licence condition, to the Head Office ALPI every three months in arrears.

2.32 This licence holder must also obtain the exposure records for their employees while their employees were working for other licence holders. They must retain the records for 40 years.

Box 2.2 Licence holders who supply labour (main points)

All licence holders in this category will be responsible for:

- their employees' training (including refresher), medical surveillance, face-fit testing, RPE provision and maintenance of ongoing health records;
- only supplying their employees to work under the supervision of another licensed contractor;
- providing the licence holder, who has hired in the labour, with face-fit, medical, training etc records for their employees for the purposes of on-site documentation;
- obtaining exposure records for their employees during the periods of the hire;
- notifying the Head Office ALPI every three months of their contracts (this is not required if the licence holder supplies labour on an infrequent basis, see paragraph 2.27).

Licence holders who actually do the work and hire in labour

2.33 Licence holders in this category will be responsible for:

- the POW and equipment specification;
- all plant and equipment;
- supervising, managing and being responsible for work practices/work on site;
- supplying PPE for employees, including hired personnel (the licence holder supplying the labour will provide their employees with their own RPE);
- notifying the work (on an ASB5) to the enforcing authority;
- checking that the hired employees have been trained successfully, face-fit tested for RPE and have undergone a medical etc. Copies of these records should be kept with other site documentation;
- recording exposure levels for the hired employees and ensuring this information is provided to the licence holder who supplied the labour, for maintenance of health surveillance records.

Supplying supervisory or management personnel

2.34 If a licence holder supplies an employee to work in a supervisory or management capacity for another licence holder, then both licence holders are deemed to have responsibility for the work. In such situations, both companies are required to notify the enforcing authority at least 14 days before work begins. Organisations who hold restricted licences and act as 'recruitment agencies' are only permitted to supply personnel at operative level (see paragraph 2.30).

Chapter 3: Risk assessments, plans of work and notifications for work with ACMs



Summary

- **Risk assessments:**
 - should identify all the risks associated with the asbestos work;
 - should be carried out by a competent person;
 - should describe the work, the expected exposures and methods of control.
- **Plans of work:**
 - should include the site-specific details of the work (scope, removal methods, all procedures and arrangements for smoke testing, air monitoring etc);
 - should include a detailed diagram of the location of the work routes;
 - should be made available to employees, others involved in the work and the analyst.
- **Notifications and waivers:**
 - should be made to the enforcing authority, 14 days before work is due to start;
 - waivers, permitting an earlier start date, are only given for genuine emergencies.

Contents

Introduction 40

What is the difference between an RA and a POW? 40

Risk assessments 40

Why are RAs needed and when should they be done? 40

Who should do the RA? 40

What should an RA cover? 41

What should be recorded? 42

When should assessments be reviewed? 43

Plans of work 43

Why are POWs needed? 43

What does the ACOP say should be included in a POW? 43

What does this mean in practice? 44

What should be considered in POWs by full licence holders? 45

What should be considered in POWs by supervisory licence holders? 46

What should be considered in POWs by ancillary licence holders? 47

When and why do POWs have to be provided to enforcing authorities? 48

When should POWs be reviewed? 48

Notifications and waivers 48

Notifications 48

Waivers 49

Paperwork required on site 50

For the contract 50

For the equipment 51

For your employees 51

Appendix 3.1: ASB5 notification 52

Appendix 3.2: Site diagram 53

Introduction

3.1 This chapter covers RAs, POWs and notifications for licensable work with asbestos insulation, asbestos coatings and AIB.

What is the difference between an RA and a POW?

3.2 An RA is the process the employer undertakes to establish all the risks associated with the asbestos work and the precautions needed to prevent or minimise those risks. The POW or method statement is specific to a particular job. Its purpose is to provide a practical document, which summarises the key control measures resulting from the RA. These measures are based on the specific features of a particular location and the work involved. The POW is intended to direct the work of the asbestos removal team (including the analyst).

3.3 There is clear overlap between the content of the RA and the content of the POW. It is therefore acceptable where such overlaps occur, that information is not repeated. POWs will often contain material that under the following guidance is referred to as part of the RA.

Risk assessments

Why are risk assessments needed and when should they be done?

3.4 Regulation 6 of CAWR requires employers to undertake a suitable and sufficient RA before carrying out any work which is liable to expose their employees (and others who may be affected by the work) to asbestos.

The RA should ensure that all potential risks to health are fully considered

3.5 The RA ensures that the scope of the proposed works is properly considered, so the potential risks can be fully established. This will help identify appropriate work methods, so exposure to asbestos can be adequately controlled and legal obligations satisfied. For this reason, it should be done in time to allow for compliance with all the relevant regulations and to enable the appropriate precautions to be taken before work begins. The assessment process can also be assisted by involving employees. Workers are extremely well-placed to identify problems and issues and can assess the practical implications of work methods and control systems. They will be able to assist in the development of effective and workable risk control measures.

Who should do the RA?

3.6 The RA must be done by a competent person who should:

- have adequate knowledge, training and expertise in understanding the risks from asbestos;
- know how the work activity may disturb asbestos;
- know what precautions should be taken to minimise exposure to asbestos;
- be familiar with and understand the requirements of CAWR and the appropriate Approved Codes of Practice;
- have the ability and the authority to collate all the necessary, relevant information;
- have the knowledge, skills and experience to make informed decisions about the risks and precautions that are needed; and
- be able to assess non-asbestos risks on site.

What should an RA cover?

3.7 The RA should identify all the risks associated with the asbestos work. Guidance on what the RA should include is set out in paragraphs 3.7-3.13. The RA should include:

- a description of the work (eg repair, removal, encapsulation of ACM or maintenance and testing of plant and equipment contaminated with ACMs) and a note of the scale and expected duration of the work;
- details of either the type of asbestos and the results of any analysis, or a statement that the asbestos is not chrysotile alone, so that the stricter action levels and control limits apply;
- the quantity, extent, condition, thickness and type of ACM, including how it is fixed or attached to substrates.

3.8 The items listed in paragraph 3.7 cover specific matters (such as the work activity, and the asbestos product and type (including condition)), so that the appropriate control regime can be implemented. It is essential to establish the asbestos product to confirm that the licensing regulations apply. It is also important to have information on the physical status of the ACM. Knowing the condition and thickness is particularly relevant to establish the finer details of the removal method, eg the type and shape of wet injection needles to be used, and if any preparation work is required (such as pre-drilling or arrangements to attach needles or the need for a coating). Also knowing how the ACM is attached or fixed to the adjoining material (glued, nailed, screwed, or a combination), is important to ensure that the removal steps can be properly planned and the most appropriate removal technique or combination of techniques are used.

3.9 In addition, having information on the material size and location (eg its length and span, whether it extends into other rooms and work areas) is important. It means the number of enclosures required, and the necessary arrangements for the transfer of waste, can be properly assessed. The extent of any overspray, debris or other contamination beyond the actual ACM should also be established. This information will help to avoid any confusion over the work being done and which ACMs will remain in place.

3.10 The assessment should also include:

- details of expected exposures, noting:
 - whether they are liable to exceed a control limit or an action level and the number of people likely to be affected;
 - the level of the expected exposure, so that suitable RPE can be assessed and selected;
 - whether anyone other than employees may be exposed, and their expected exposures;
 - whether intermittent higher exposures may arise; and
 - results already available from air monitoring in similar circumstances;
- the steps to be taken to control exposure to the lowest level reasonably practicable, eg the type of controlled wetting and method of application, the use of local exhaust ventilation (LEV) (eg shadow vacuuming), glovebags and wrap-and-cut;
- the reasons for the chosen work method. Full justification is required if work removing coating, lagging and AIB is planned to be carried out:
 - dry; and/or
 - in hot conditions; and/or
 - using abrasive power tools that impact material.

Except under exceptional circumstances dry work, hot work and work using power tools is not acceptable and must not be carried out

3.11 Hot work is to be avoided where possible. It introduces heat stress risks, which are extremely difficult to manage, and it can lead to deterioration in asbestos control. It will only be permitted in exceptional and fully justifiable circumstances. Hot work is discussed in paragraphs 7.72-7.80. The thermal risks from hot working should be assessed under other regulations (see paragraph 3.13).

3.12 Also included in the RA should be:

- the steps taken to control the release of asbestos into the environment, eg:
 - enclosures and negative pressure;
 - where an enclosure is not planned (ie the RA shows an enclosure to be unnecessary), including when wrap-and-cut and glovebags are being proposed, a full justification is required on how the potential spread of asbestos is to be prevented, including arrangements for segregation;
 - decontamination procedures.
- procedures for the removal of waste and contaminated tools and equipment from the work area and the site;
- procedures for the selection, provision, use and decontamination of PPE, which includes RPE;
- the arrangements to ensure the premises or parts of premises where the work has taken place are left clean and safe for reoccupation. These should include:
 - details of the areas where clearance certification will be sought;
 - consideration of potential problems for clearance certification, eg earth floors, limpet spray ingrained in concrete or tar-like layers, wet areas which cannot be dried out and the presence of ACMs which are intended to remain in the areas after the work is complete;
 - consideration of the need for pre-cleaning (often required before setting up any enclosure);
- procedures for dealing with emergencies, including, eg those associated with work in confined spaces;
- the results of relevant medical surveillance;
- any other information relevant to safe working such as other significant non-asbestos hazards like working at heights or in confined spaces (see paragraph 3.13);
- any additional information that may be needed to complete the RA.

The RA should also include non-asbestos risks such as falls from height or work in confined spaces

3.13 Depending on the work involved, employers may also have duties under other sets of regulations to carry out a separate RA. For instance, if employees are likely to be exposed to other risks such as falls from height, confined spaces or hot conditions, assessments will be required under the Management of Health and Safety at Work Regulations 1999.¹⁰ The results of these RAs should be forwarded to all interested parties, eg the analyst.

What should be recorded?

3.14 The significant findings of the RA should be recorded in writing and should form the basis of the POW (see paragraphs 3.17-3.31). All of the findings from paragraphs 3.7, 3.10 and 3.12 are deemed to be significant. A copy of the significant findings of the assessment should be kept readily available on site for the duration of the work to which they relate; in practice the significant findings will often end up as part of the POW.

When should assessments be reviewed?

3.15 Employers should promptly review assessments when there is any reason to suspect they are no longer valid, where there is a significant change in the work to which the assessment relates, or when the results of any air monitoring or medical surveillance show a review is necessary. Any changes to the assessment (and potentially the POW, see paragraph 3.31) should then be made as appropriate.

Plans of work

Why are POWs needed?

3.16 Regulation 7 of CAWR requires that an employer prepare a suitable written POW before any work with asbestos is undertaken. The RA is a vital first step to inform the POW (see paragraph 3.2).

3.17 The purpose of the POW (often called a method statement) is to provide a practical document, which details the specific work methods and control measures for a particular job at a particular location. The document directs the work and is a source of reference for the asbestos removal team. The POW is an active document and if any significant changes on site are necessary, it should be amended and the changes communicated to the employees. The changes should also be notified in writing to the enforcing authority.

3.18 Employers must make sure their employees follow the POW so far as it is reasonably practicable to do so. If the work cannot be carried out in accordance with the plan, it must be stopped and the risks reassessed. Work should not start until a new POW is drawn up or until the existing plan is amended.

What does the ACOP say should be included in a POW?

3.19 Paragraph 35 of *Work with asbestos insulation, asbestos coating and asbestos insulating board. Control of Asbestos at Work Regulations 2002. Approved Code of Practice and guidance*¹² states that the POW should be site-specific and should cover in sufficient detail the following information:

- the scope of the work as identified by the RA (see paragraph 3.7);
- the address and location where the work is to be carried out;
- the methods to be used for the work with the asbestos or ACM as identified in the assessment, eg the prevention and control measures and the handling and disposal of the waste (see paragraph 3.12); and
- the type of equipment, including PPE and procedures, used for:
 - the protection and decontamination of those carrying out the work, including details of the hygiene facilities, transit route and decontamination arrangements, vacuum cleaners, air monitoring, protective clothing and RPE, communication between the inside and outside of the enclosure;
 - the protection of other people at or near the work site, including the use of barriers and signs, location of enclosures and airlocks, location of skips, NPUs, air monitoring, cleaning and clearance certification, emergency procedures.

A POW should include a detailed site diagram

3.20 The ACOP suggests other things that could be included as good practice. These are details of checks undertaken for other hazards, the name of the supervisor and the name of the organisation that will undertake site clearance certification, and details of other nearby ACMs which have not to be removed. Listing nearby ACMs should prevent confusion between the work being done and ACMs remaining in place.

3.21 In all cases, work should not be undertaken until there is a copy of the POW available on site. The plan should be made available to employees, and to any others involved in the work, as necessary. Full licence holders should also make the plan available to the analyst who is carrying out the four-stage clearance process. The plan should remain on site for the duration of the work to which it relates.

The POW should be made available to employees, others involved in the work and the analyst who will carry out the four-stage clearance

What does this mean in practice?

3.22 The POW should contain the site and task-specific information. This is the information which relates to the site and job, the layout and design of the work area and enclosure, and the specific controls which will be employed. The POW should contain such information as the location of the DCU, the transit route and how a modular DCU is to be deployed and restricted to use by one or two people etc.

3.23 Generic information covering company procedures should **not** be included in individual POWs. Instead this information should be contained in the latest version of the company's standard procedures, a copy of which should be held on every site. These procedures only need to be expanded upon in the individual site-specific POW when the site proposals differ from the generic information. The items that can be covered in standard procedures are listed in Box 3.1.

Box 3.1 Items that can be covered in standard procedures

- Some control measures (eg construction and testing of enclosures, barriers, warning notices etc).
- Use of PPE including RPE (eg selection, use, face fits, system of coloured coveralls etc).
- Air monitoring (eg personal, background etc).
- Site inspection (eg supervisory arrangements).
- Checking and maintenance of equipment (eg testing and certification of NPUs and RPE etc).
- Decontamination (eg preliminary and full procedures, hygiene facilities etc).
- Waste (eg bagging, transporting, storage).
- Emergency arrangements (eg fire, enclosure breach, unplanned ACM disturbance etc).

3.24 A copy of the current version of the company's standard procedures, bearing the relevant reference number and date, should be sent to the HSE Head Office ALPI for their retention and future reference. A copy, where requested, should also be made available to other enforcing authority inspectors and any personnel involved in the work. This applies to all licence holders.

Generic POWs are not acceptable, unless they are designed to cover a series of very similar asbestos removal jobs, such as at a block of flats or a series of houses in one location where the method is applicable to each property

3.25 Paragraphs 3.26-3.31 provide a practical interpretation of the ACOP requirements in respect of the POW for the three different types of licence holder, namely full, supervisory or ancillary licence holders (ALHs). The paragraphs summarise the site-specific information that should be considered in a POW for each of the different licence holders. (Remember however that the site-specific information should be expanded upon in the POW if it differs from the generic procedures).

What should be considered in POWs by full licence holders?

3.26 The site-specific details that should be covered by full licence holders are as follows.

Details of contract

- The name and local address of the people to whom the licence holder is contracted.
- The names, job titles, and telephone numbers of all relevant contacts, including the site supervisor and the competent person preparing the POW.
- When the supervisor will be on site.
- The number of employees on the job at any time.
- When the work is going to take place, ie dates and times (days, nights, weekend work, etc), the dates for set up, removal and clearance.
- The names of the principal contractor, the planning supervisor and client, if the Construction (Design and Management) Regulations 1994¹¹ apply.
- The name(s) of any other asbestos licence holders involved.
- The name of the analyst or organisation that will carry out the four-stage clearance process and issue the certificate of reoccupation. It should also state who has contracted the analyst.

Scope of work and RA

- Brief details of any asbestos survey, the level (Type 1, 2 or 3) who did this and when.
- A description of the work, its location and the removal method.
- The type and form of asbestos, the quantity, extent and condition.
- Brief details of any access and fire risks and precautions taken, and any other risks (eg working at heights, hazardous substances).
- Who has authority to consider departures from the POW and how will these be noted and recorded on site, and reported to the enforcing authority?

Control measures

- The expected exposure using the controls specified.
- The steps taken to reduce exposure as low as reasonably practicable and to control release into the environment.
- A site diagram - see Box 3.2.
- The volume of enclosure, size and numbers of NPUs and number of air changes per hour.
- If NPUs conform to PAS 60-2 (see Box 7.1).
- The type of respirators actually used.
- The air monitoring arrangements for the duration of the work.
- The arrangements for smoke testing and witnessing.
- The arrangements for maintaining control measures on site and what checks are to be in place.

Method of work for removal

- Any additional precautions to reduce exposure.
- Detailed site information and a site-specific description of the working method to be used with reasons.
- Details of the fibre-suppressant technique to be used.
- For a wet strip system: describe the injection technique, approximate time allowed for penetration, what indicator will be used to check **all** the material is fully saturated. State whether equipment complies with PAS 60-1 standard (see Box 7.1).
- The tools and other equipment to be used.
- For AIB work, details of the practical measures to minimise dust release, and information on the way the ACM is fixed to the substrate.
- For other wetting systems, state the type to be used, eg airless spray, spray unit.

Other relevant site-specific information (but only where it differs from the standard procedures)

- DCUs (eg use of modular units, security issues).
- Entry and exit procedures to the areas of working.
- Welfare facilities.
- Waste disposal.
- Emergency procedures.

Box 3.2 Site diagram

The diagram supplied as part of the POW should show the following:

- the enclosure(s) or work area(s);
- adjacent rooms or areas to the enclosure or work area;
- location of viewing panels;
- location of NPUs;
- location of the airlock;
- location of the baglock;
- location of the hygiene unit;
- location of the skip;
- transit route;
- waste route;
- size and dimensions of the enclosure or work area, adjoining rooms, transit and waste routes.

What should be considered in POWs by supervisory licence holders?

3.27 The supervisory licence enables the holder (ie SLH) to have direct and immediate influence and control over site activities to assist all dutyholders involved in the work in achieving compliance with CAWR. For SLHs, the POW needs only to spell out site-specific details in relation to the licence holder's role supervising the main removal contractor. The site-specific details that should be covered by the SLH are as follows.

Details of contract

- The name and local address of the SLH's client, ie people the SLH is contracted to.
- The name of the licensed asbestos contractor(s).
- The names, job titles and telephone numbers of all relevant contacts, including the site supervisor and the competent person preparing the SLH plan of work.
- When the SLH supervisor will be on site.
- When the work is going to take place, ie dates and times (nights, weekend work, etc), the dates for set up, removal and clearance.
- The names of the principal contractor, planning supervisor and CDM client, if CDM applies.

Scope of work and RA

- Brief details of any asbestos survey, survey type (ie Type 1, 2 or 3), author and date.
- A **brief** description of the work to be undertaken by the licensed removal contractor(s) and its location and the removal method.
- The type and form of asbestos, the quantity, extent and condition.
- Brief details of any access and fire risks and precautions taken.
- The terms of reference for the SLH's involvement in the work (what exactly will the SLH be doing?).
- Who will consider departures from the POW and how will these be noted and recorded on site.

Supervisory licence holder's 'own work'

- The arrangements for communications with the various parties involved, ie the SLH's client, licensed removal contractor(s), analysts etc. Does the SLH's client and the licensed asbestos contractor understand the role?
- The arrangements to check the licensed contractor's documentation (eg test certificates for equipment; medical certificates; method statements; maintenance records; site log (including daily check of the enclosure and DCU); training records (for asbestos work); face-fit test records for RPE; records of RPE inspection; copy of the licence).
- The type of respirators used.
- The arrangements in place to stop or modify work practices (is the SLH certain that they have the power to ensure that action is taken?).
- The arrangements for air monitoring (when, where, by whom, type, recording of exposure levels).
- The arrangements for four-stage clearance procedure and the arrangements to resolve any issues that arise, eg unsealed surfaces in the enclosure or a wet enclosure.
- The arrangements for DCU clearance testing.

Other relevant site-specific information

- Use of the DCU.
- Entry and exit procedures.
- Welfare facilities.
- Emergency procedures.

What should be considered in POWs by ancillary licence holders?

3.28 The site-specific details that should be covered by the ALH are as follows.

Details of contract

- The name and local address of the people to whom the ALH is contracted.
- The name of the licensed asbestos contractor(s).
- The names, job titles, and telephone numbers of all relevant contacts, including the site supervisor and the competent person preparing the POW.
- When the ALH supervisor will be on site.
- The number of employees on the job at any time.
- Details of when the ALH's work is going to take place, ie dates and times (nights, weekend work, etc), the dates for scaffold erection, dismantling etc.
- The names of the principal contractor, planning supervisor and CDM client, if CDM applies.

Scope of work and RA

- A description of the work and its location.
- The type and form of asbestos, the quantity, extent and condition.
- Brief details of any access and fire risks and the precautions taken.
- Who will consider departures from the POW and how these will be noted and recorded on site.

Control measures

- What measures will be used to reduce exposure.
- The type of any respirators used.

Method of work

- Detailed site information and a site-specific description of the working method to be used with reasons.
- What tools and other equipment are to be used.

Other relevant site-specific information

- Use of the DCU.
- Entry and exit procedures.
- Welfare facilities.
- Emergency procedures.

When and why do POWs have to be provided to enforcing authorities?

3.29 POWs should be provided to the enforcing authority as part of the notification process at least 14 days before the work is due to start (see paragraphs 3.32-3.35). The enforcing authority does not approve POWs. However the notification period gives the enforcing authority the opportunity to assess the proposals contained in the POW and to inspect the site either before or during the work if they choose to. If a particular POW does not contain the minimum information required by regulation 7 of CAWR, it is liable to be rejected. The licence holder will be informed of the deficiencies and may have to resubmit their POW. Where resubmission is required, a new 14-day notification period will apply.

When should POWs be reviewed?

3.30 As with RAs, POWs should be reviewed when there is reason to suspect they are no longer valid, particularly if:

- fibre control methods change (eg multipoint injection replaced with airless spraying);
- there is doubt about the efficiency of the control measures (eg dry patches occurring during multipoint injection removal);
- there is a significant change in the type of work, method of work, or extent of the work (eg more and/or different types of ACM are discovered);
- there is a change of site layout/access arrangements;
- the results of air monitoring indicate the exposure levels to be higher than previously assessed; or
- the results of medical surveillance show that a review is necessary.

3.31 Any changes made later must be recorded in writing and be notified (in writing) to the enforcing authority and employees.

Notifications and waivers

Notifications

3.32 As indicated in Box 2.1 and paragraph 3.29, licence holders are required as a condition of their licence to notify the enforcing authority (either HSE or the local authority) with details of the proposed work at least 14 days before it is due to start. The notification consists of a completed ASB5 form (see Appendix 3.1) (or equivalent), a suitable and sufficient POW (or method statement) and equipment specification, and a copy of the licence. Each licence holder involved in a particular job (ie, full, supervisory or ancillary licence holder), must submit their own notification.

3.33 All notifications received by HSE are subject to an administrative check for completeness, timeliness of submission etc. If any of the papers are missing (eg the site diagram) or are inadequate, then the notification is incomplete and the 14-day notification period will not start. Enforcing authorities do not agree or approve notification, nor do they approve method statements/POWs or acknowledge receipt of them. However, licence holders are encouraged to submit their notifications to HSE by e-mail and to set their system to receive an automatic acknowledgement of receipt.

3.34 A proportion of notifications are selected for closer scrutiny. As outlined in paragraph 3.29, if HSE finds deficiencies, then the licence holder will be informed and may have to resubmit their POW. The 14-day notification period will only start once a modified plan is received. Any changes to the POW should be notified in writing to the relevant enforcing authority office. Again, the notification period will only start when the modified papers are received in the appropriate enforcing authority office. Papers arriving outside normal office hours will be deemed to have been received the next working day.

3.35 Employers doing work on asbestos insulation, asbestos coating and AIB on their own premises, with their own employees, are exempt from holding a licence, but they must notify under regulation 5 of ASLIC. This requires them to give the relevant enforcing authority 14 days written notice of their intention to carry out work. The notification should include the address and telephone number where the work is to be carried out, and a description of the work. A single notification is permissible for work which is likely to be regularly repeated on the premises.

Waivers

3.36 There may be occasions when a **genuine emergency** arises, as a result of which the enforcing authority may allow a shorter period before the work begins.

3.37 It is HSE's policy that waiver requests will be granted only when there is a genuine emergency or equally pressing reason. Examples of such situations are:

- cases where there is an imminent risk to health, the environment, or where there is public alarm, and the risk cannot be avoided simply by leaving the area and allowing it to remain undisturbed, and/or the area cannot be sealed;
- cases where asbestos is found during work and its presence would not have been reasonably foreseeable or reasonably practicable to detect (eg unless an intrusive Type 3 survey was undertaken), **and** where the delay caused by waiting for the 14-day notification period before dealing with the asbestos would lead to significant financial loss;
- cases where a breakdown in plant or equipment requires urgent remedial action;
- cases where there is or is liable to be worry or hardship for domestic clients, including old or infirm people.

3.38 In an emergency, a waiver may be granted based upon telephone notification. However this must be followed by the paperwork listed in paragraph 3.40.

3.39 Waivers are unlikely to be granted to accommodate lack of foresight and planning by a client or contractor, unless an immediate risk of significant exposure has been created and the area concerned cannot be sealed off to prevent that exposure.

3.40 All waiver requests **must** be sent with:

- the ASB5;
- a suitable and sufficient method statement and equipment specification, including a site diagram (see Box 3.2);
- written confirmation from the contractor's client to support the request (ie evidence from the client that there is an emergency or equally pressing reason, see paragraph 3.44).

3.41 If disaster recovery work is proposed at short notice out of normal hours, HSE will accept a request by fax or e-mail (local office arrangements for the latter permitting) to waive the normal 14-day notification period for emergency weekend

or bank holiday work provided:

- the request is made as soon as practicable after the company is asked to undertake the work;
- the work with asbestos material is limited to that which is necessary to deal with the immediate emergency to make a situation safe; and
- the request includes the information normally expected for any waiver request, as listed in paragraph 3.40.

3.42 HSE will review any requests for waivers received in such circumstances to check that they satisfy these criteria. If it transpires that companies making out-of-hour requests appear to be undertaking work which does not arise from a genuine emergency, HSE may consider enforcement action, licence amendment or refusal to accept further waiver requests from such companies.

3.43 The dates stated on the waiver request for a smoke test and for the start of work must be adhered to unless alterations are agreed with the appropriate inspector.

3.44 Written confirmation from the contractor's client should provide:

- client and location details. This should include the name and address of the client, the nature of the activity at the client's address, the number of people based there and the number affected by the asbestos-related problem;
- a description of the location of the asbestos, its type and condition before the problem arose;
- a description of the steps taken to identify and manage the asbestos in these premises (submitting the asbestos survey report if applicable);
- a description of the nature of the problem in detail, the extent of the damage to asbestos and how and why it occurred, and whether the damage was foreseeable;
- a detailed description of the consequences if a waiver to the 14-day notification is not granted.

Paperwork required on site

3.45 The list below outlines the paperwork that should be on site for the duration of the contract. If original certificates are not available on site, the copies kept on site should be authenticated at a senior management level to provide confirmation of their validity.

For the contract

- Current asbestos licence.
- POW (method statement), including details of any modifications that have been made and notified to the enforcing authority.
- ASB5 notification and waiver (where granted).
- Other RAs (including assessments under the Control of Substances Hazardous to Health Regulations 2002 (COSHH) (as amended)¹⁶ and assessments made under the Management of Health and Safety at Work Regulations 1999).¹⁰
- Employer's liability compulsory insurance certificate.
- A copy of the company's current standard procedures.
- Site log.

For the equipment

- Test certificates for NPUs and any other plant in use (as appropriate).
- A clearance certificate for the DCU.
- Inspection reports for RPE, thorough examination and test plant etc.
- Daily records of checks on enclosure, DCU and air extraction.
- Smoke test certificate.

For your employees

- Medical certificates for all personnel working with asbestos.
- RPE face-fit records for all personnel working with asbestos. Where several pieces of RPE are in use, face-fit records should be on site for all types.
- Training records for all personnel working with asbestos.
- Personal monitoring results (if performed).

Appendix 3.1 ASB5 notification

	<p>Health and Safety at Work etc Act 1974 Asbestos (Licensing) Regulations 1983</p>	<p>Notification Form</p> <p>Click here for a list of HSE Offices / EMail addresses</p>
	<p>• Please read the notes attached before completing this form • Please use block capitals</p> <p>• When completed, please return this form to the appropriate authority • This form may be photocopied for use in subsequent notifications.</p>	
<p>1 Licence holder details Click here for guidance</p>		
Name	<input type="text"/>	Licence number <input type="text"/>
Address	<input type="text"/>	
		Expiry Date <input type="text"/>
		Postcode <input type="text"/>
Telephone No	<input type="text"/>	Fax No <input type="text"/>
e:mail address	<input type="text"/>	
Name of person dealing with job	<input type="text"/>	Mobile Telephone No <input type="text"/>
<p>2 Occupier or employer or contractor to whom the licence holder is contracted</p>		
Name	<input type="text"/>	Contact person <input type="text"/>
Telephone No	<input type="text"/>	Mobile Telephone No <input type="text"/>
<p>3 Details of job</p>		
Site address where asbestos work is to be carried out	<input type="text"/>	
		Local Authority Area <small>(see note 1 attached)</small> <input type="text"/>
Exact work location/description of where on these premises work is to be carried out <small>(see note 2 attached)</small>	<input type="text"/>	
Site telephone no: <input type="text"/>	Actual start date of set up on site <small>(see note 3 attached)</small> <input type="text"/>	Expected duration of work <small>(days)</small> <input type="text"/>
<p>Type of work to be undertaken <small>(please tick a box)</small></p>		
Asbestos coating <input type="checkbox"/>	Textured coating (Artex) <input type="checkbox"/>	Asbestos insulation <input type="checkbox"/>
		Asbestos insulating board <input type="checkbox"/>
Other <input type="checkbox"/>	<small>(please specify)</small> <input type="text"/>	
Activity - does the work involve?	Dry stripping <input type="checkbox"/>	Use of power tools <input type="checkbox"/>
		Work on or in proximity to hot surfaces <input type="checkbox"/>
<p><small>(These work methods should be avoided. If you have ticked any of these boxes justification must be included in a separate note: specific reference to control measures must be included in the method statement)</small></p>		
Size of job <small>(see note 4 attached)</small> <input type="text"/>	Maximum number of persons employed in the work at any one time <input type="text"/>	
<p>4 Other asbestos licence holders information</p>		
Are any other asbestos licence holders involved in the work/subject?	Yes <input type="checkbox"/>	No <input type="checkbox"/>
Name	<input type="text"/>	
In what capacity are they involved? (eg supplying labour, ancillary/supervisory work)	<input type="text"/>	
Signature	<input type="text"/>	Date <input type="text"/>
Print Name	<input type="text"/>	Position <input type="text"/>
<p>The notification period starts when this form, accompanied by a suitable/acceptable method statement is received by the enforcing authority</p>		

Appendix 3.2 Site diagram

(a)

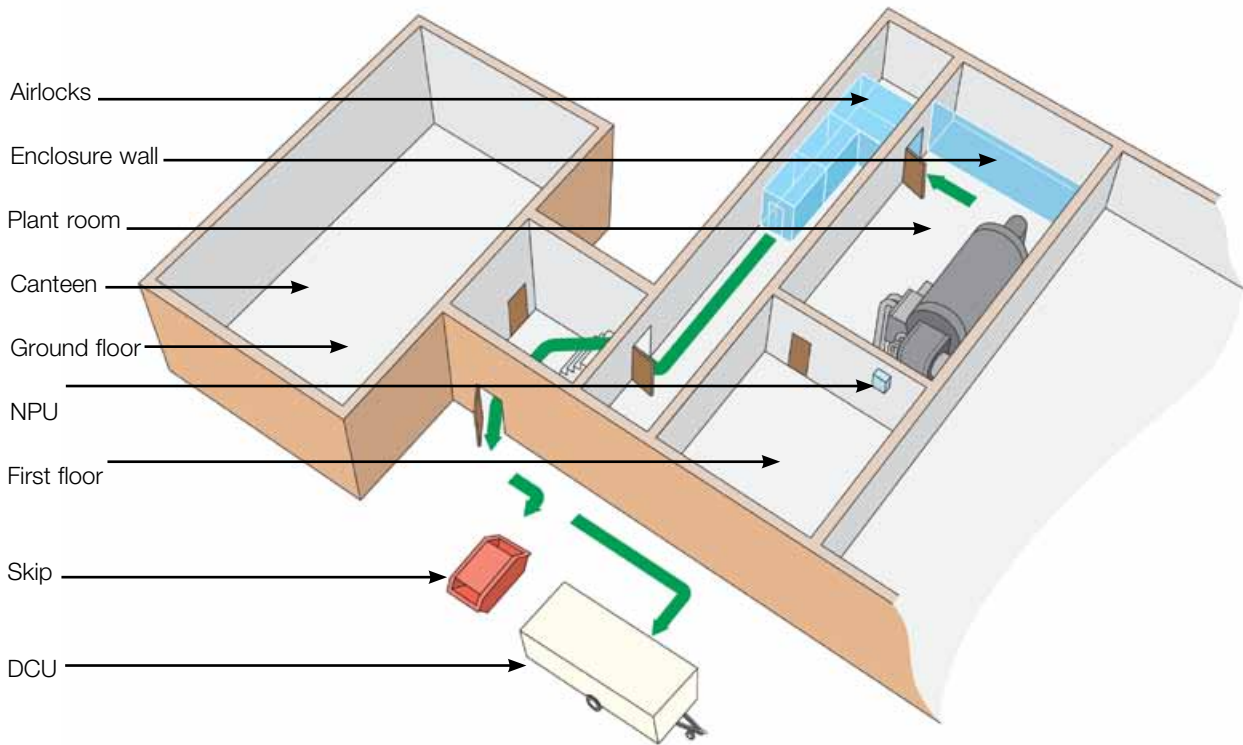

(b)

Recording of the site layout as a diagram, (a) shows the 3-dimensional layout and (b) is an example of how the site could be recorded as a clearance diagram. Dark areas show work areas and light areas show other areas which need to be inspected.

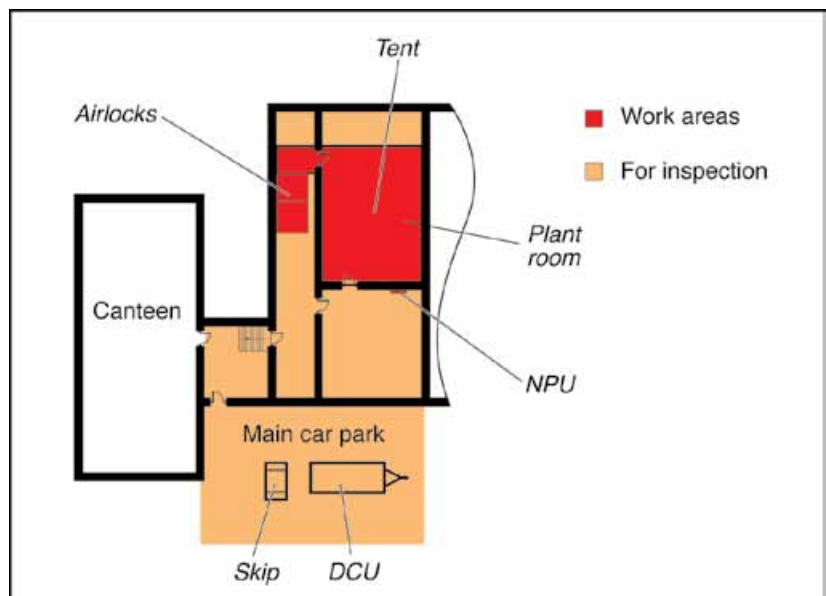

Chapter 4: Training for employees, supervisors and others working with ACMs



Summary

- Employees of licensed asbestos companies should not be allowed to start work without having received the appropriate level of training.
- There should be a clear training strategy and policy.
- Take care over either the development or choice of the appropriate training courses, with particular reference to the use of a training needs analysis.
- Training courses should be designed to meet the course criteria in Appendix 4.3 and the course content in Appendices 4.1 and 4.2.
- Training is not an end in itself and must be followed up by on-the-job consolidation of the knowledge and skills acquired.
- Senior management should ensure that the training policy continues to be implemented and is still relevant.

Contents

Introduction 56

Why is training required? 56

Training strategy model 56

Stage 1: Drawing up a training policy 57

Stage 2: Identifying training needs 57

Stage 3: Choosing an external training course or developing in-house training 57

Stage 4: Checking that appropriate training has been delivered 61

Stage 5: Record-keeping 61

Stage 6: Consolidation of skills and knowledge 62

Stage 7: Monitoring, auditing and policy review 62

Further information 62

Appendix 4.1: Asbestos training modules 1-23 (scaffolders 20-23 only): Initial training 63

Appendix 4.2: Asbestos training modules 24-27: Practical training 70

Appendix 4.3: Course criteria for people carrying out or supervising asbestos removal or ancillary work 71

Appendix 4.4: Carrying out a TNA 73

Introduction

4.1 This chapter explains the nature of the training that should be given to the various types of personnel involved in licensed asbestos removal work, ie asbestos removal organisations, SLHs and ALHs. The guidance contains an outline plan for the training required for the different personnel. The training topics are presented in the form of modules (see Appendices 4.1 and 4.2). The training modules have been prepared taking into account the European level report *Final report on the development of practical guidelines for the training of asbestos removal workers*.¹⁷ Appendix 4.3 contains the agreed design criteria that asbestos courses should follow. The three appendices have been drawn up after consultation with the asbestos training providers known to HSE (a list is available at www.hse.gov.uk).

Why is training required?

4.2 Regulation 9 of CAWR requires employers to ensure that adequate information, instruction and training are given to their employees who are liable to be exposed to asbestos or who supervise such employees. The aim of this regulation is to ensure that employees are equipped with the relevant skills and knowledge to enable them to remove asbestos safely or to supervise such work, by minimising their exposure to asbestos.

4.3 Following this guidance will help employers to fulfil the training requirements set out in paragraphs 42-60 of the ACOP, *Work with asbestos insulation, asbestos coating and asbestos insulating board. Control of Asbestos at Work Regulations 2002. Approved Code of Practice and guidance*.¹² This includes the need to provide role-specific training for all employees working with asbestos.

4.4 Training on its own does not make people working with asbestos 'competent'. Training must be consolidated so that the person becomes confident, skilful and knowledgeable in practice on the job (see paragraph 4.37).

Training strategy model

4.5 To assist in meeting training needs, all organisations involved in asbestos work should have a training strategy. Paragraphs 4.6-4.41 provide the details of a model for a training strategy (see Box 4.1).

Box 4.1 Training strategy model

Stage 1: Drawing up a training policy.

Stage 2: Identifying training needs.

Stage 3: Choosing an external training course or developing in-house training.

Stage 4: Checking that appropriate training has been delivered.

Stage 5: Record-keeping.

Stage 6: Consolidation of skills and knowledge.

Stage 7: Monitoring, auditing and policy review.

Stage 1: Drawing up a training policy

4.6 The training policy should set out the following points.

- Who is responsible for managing the training policy.
- How training needs will be identified.
- Whether the organisation has the competence and resources to deliver training itself or requires the assistance of a training provider.
- What to do if an employee fails a training course.
- How to determine whether training objectives have been met.
- How training will be recorded and kept up to date.
- How follow-up, on-the-job training will be implemented to consolidate new skills and knowledge.
- How to identify training needs for refresher training.
- How to monitor and review the policy.
- How the competence of the employee will be determined.

Stage 2: Identifying training needs

4.7 What is a 'training need'? A training need is a specific change in behaviour that is required to improve performance in a particular job or to bring a new recruit up to speed. The technique called 'training needs analysis' (TNA) involves a description of the difference between the existing behaviour and a desired behaviour. For example, an experienced asbestos removal operative fails to follow the correct decontamination sequence or a new recruit does not know the right way to decontaminate. In these instances, the training need would be 'to understand and apply the decontamination procedure in the right order' and a training programme should be chosen or drawn up that meets this need. A guide to carrying out TNA and an accompanying flow chart can be found in Appendix 4.4. TNA is especially relevant for refresher training to ensure that the course is tailored to the audience and is not a repeat of the basic training course. Everyone employed to work with (or work ancillary to) asbestos insulation, asbestos coating or AIB must have their training needs assessed before they start work or before attending a refresher course. TNA can be carried out on a group of people and not just on an individual basis. Training needs should be identified by managers as part of ongoing site monitoring. It is an employer's responsibility to ensure that a TNA is carried out, either in-house or with help from external consultants.

Stage 3: Choosing an external training course or developing in-house training

4.8 Training can be delivered in-house provided that the expertise and resources are available. Staff should have the necessary skills, knowledge and experience to be trainers (see paragraph 4.29) and there should be suitable training facilities. The alternative option is to use external training expertise. In both instances the guidance in paragraphs 4.9-4.29 can be used to find/develop suitable training for asbestos workers.

Course content

4.9 The content of the different types of training has been set out in a series of modules covering core topics for basic training, role-specific modules and refresher training. These modules are based on the list of training topics set out in the ACOP, *Work with asbestos insulation, asbestos coating and asbestos insulating board. Control of Asbestos at Work Regulations 2002. Approved Code of Practice and guidance*¹² (see Appendices 4.1 and 4.2). When choosing an external course or designing an in-house course, these modules should be followed.

4.10 Appendix 4.3 sets out training course design criteria such as duration, tutor to delegate ratio etc, for basic, role-specific and refresher training. These criteria have been agreed with the asbestos training providers listed on the HSE website. Training providers should be questioned to ensure that the course meets these criteria. Companies providing in-house training should also follow these criteria.

Practical training

4.11 A review of training provided for operatives and supervisors carried out by the Health and Safety Laboratory (*Review of training provided to asbestos removal workers*),¹⁸ concluded that more emphasis was required on the delivery of 'practical' training to ensure that employees could follow essential procedures correctly. The term practical in this context means hands-on training where delegates practice going through procedures, usually in a simulated environment. For example:

- carrying out decontamination procedures by showering etc using a powered, live hygiene unit (uncontaminated);
- trying out RPE to ensure a good face-fit and knowing how to carry out maintenance checks;
- the simulated use of controlled wet stripping techniques, such as multi-needle injection systems;
- construction of enclosures and airlocks;
- maintenance of plant and equipment.

4.12 In general, where the training aims to impart knowledge, it will be mostly theory-based. When the training is about providing skills, the emphasis should be on practical training. The latter can be supplemented through the use of exercises and demonstrations including showing videos, taking part in case studies and visual demonstrations.

4.13 It will be important for the employer to check that the training course includes modules which have a practical element as described in Modules 24-27 in Appendix 4.2, and includes a means of gauging attainment levels. Both practical and theoretical sections of the course should be carried out by the same training provider.

Health and safety of delegates

4.14 Health and safety issues should be considered during practical training sessions. The training provider should be asked what steps have been taken to assess the risks of running practical sessions, eg risks from slips, trips and falls or from electric shock.

New recruits

4.15 **'New'** employees may have worked in the industry before, but it should not be assumed that their experience is sufficient to dispense with further training. For example, new recruits may be unaware of their employer's safety policy, in particular systems of work currently in force or the protective equipment used. They may also have received inadequate training in the past and may not fully appreciate the dangers of asbestos. Induction training covering in-house health and safety procedures will therefore be necessary for all new employees even if they have already received basic training in asbestos. This will include training in health risks, emergency procedures, waste disposal and the company's own induction before being allowed to work even outside the enclosure.

Existing employees

4.16 The continuing training needs of existing employees should be assessed regularly. Information and training updates on, eg new working techniques or changes to legislation should be given at the earliest opportunity. Do not necessarily wait for the annual refresher training which, although it is a useful vehicle for getting such information across, may be too far in the future. Evidence of delegates' successful completion of basic training should be provided to external training providers before enrolling them on refresher training.

Types of training

4.17 Delegates with different roles should not participate in the same course. Training will be based on the role of the employee. In addition, training will depend on the experience of the employee. It is divided into two categories:

- initial training;
- refresher training.

Initial training

4.18 Initial training is required for employees new to licensed asbestos work. There are certain key topics that must be covered by people involved in asbestos removal work, including SLHs, managers and directors. The depth to which trainers go will be dependent on the TNA and the role carried out by the individual(s). The Initial Training Modules 1-23 are set out in Appendix 4.1. Modules 20-23 apply to scaffolders only.

4.19 There are particular areas of training that are specific to the role of the employee. However, there are some job holders who will have to cover all topic areas to gain an understanding of what the others do, so they can manage or supervise them. Such job holders include managers, directors and SLHs. Role-specific Modules are incorporated into Appendix 4.1 and include the following roles:

- operatives;
- supervisors of asbestos removal work;
- managers and directors of asbestos removal work;
- scaffolders (and scaffolding management);
- SLHs.

Refresher training

4.20 The aim of refresher training is to identify good and bad practice and to ensure that the good practice is shared and that bad practices are stopped. TNA will help to make the annual courses more relevant to delegates. Refresher training should aim to achieve the following objectives:

- fulfil identified training needs;
- impart new information, eg changes in legislation and work practices (such as use of new equipment or wetting techniques);
- remind employees of the risks they face working with asbestos;
- reinforce procedures such as the use of hygiene facilities, use and maintenance of RPE and how to use controlled removal techniques;
- share good practice and eliminate bad practice.

4.21 It is important to ensure that staff are booked on the appropriate course, ie a refresher training course and not a repeat of the initial training modules. In the former there will be greater emphasis on carrying out practical training through the use of demonstration techniques. If training needs are identified that require practical training, the course time may need to increase to incorporate such sessions.

4.22 The term 'supervisor', 'manager' and 'director' relate to the person's responsibilities and the function of their role and not their job title. It is essential that people are sent on the course or series of modules that best reflect their role. The subjects in the modules outlined in Appendices 4.1 and 4.2 will vary in depth according to the role of the delegates. For example a supervisor will need to have good fault-finding skills to check conditions on site, whereas a director will only need an overview of what checks the supervisor should be carrying out.

4.23 Where only two or three operatives will be on site for the duration of the job (without a floating supervisor), one person should be acting in a supervisory capacity. The person should have been trained at a supervisory level and have the necessary skills and authority to supervise the others.

4.24 Directors should know about the licensing requirements and the implications of not complying with the standards set out in the ACOPs and asbestos legislation.

Assessment

4.25 The content of training and pace of delivery should be influenced by an employee's previous knowledge and experience. A trainee's performance should be assessed at regular intervals so that the course instructor can keep the employer informed about his or her progress. A test, set by the course instructor, should indicate that the trainee has successfully completed the training programme. It will also be appropriate to assess performance in practical sessions, such as the fitting of RPE (see Module 25, Appendix 4.2).

4.26 A trainee whose final assessment is unsatisfactory, or who has not completed all the core modules, should not be permitted to work in areas where exposure is liable to exceed the relevant control limit until additional training has been given and he or she has achieved a satisfactory pass mark (see 'Assessment of attainment levels' Appendix 4.3).

4.27 As an employer it is important to check that the training provider will assess delegates, as it is no longer acceptable for delegates to receive a training certificate for attendance only. Delegates should be informed of their pass mark and should be given a copy of their training certificate.

Delivery techniques

4.28 HSL's report concluded that it is very important to motivate delegates to participate in the training. It is particularly important to remember that the majority of the delegates will not be used to being in an educational environment and are more used to learning by doing. Ask the training provider which of the following techniques they use to motivate delegates:

- variation of delivery methods, eg videos, lecture style, exercise, practical;
- making the training objectives relevant to delegates' work and role;
- encouraging group discussion;
- providing feedback on progress by the means of assessment.

Competence of trainers

4.29 All training should be provided by instructors who are competent, ie they have adequate personal practical experience in the asbestos sector, theoretical knowledge of all relevant aspects of the work and the ability to deliver effective training courses. There are no set training requirements for trainers. There are, however, National Vocational Qualifications (NVQs) available in training. Trainers should be capable of identifying the most appropriate methods of presentation, how to design and evaluate courses and how to carry out the assessment of delegate performance. Employers should make enquiries about the trainer's experience and relevant qualifications.

Stage 4: Checking that appropriate training has been delivered

4.30 Employers should have checks in place to ensure that the correct training programmes have been delivered and that the right people have received the right training, ie that new asbestos workers have covered the initial modules and have not received refresher training aimed at experienced employees.

4.31 At the end of a course the training provider should confirm whether employees have passed the relevant modules. Employers should go on to check that any specified additional training objectives (ie outside the standard modules) have been met. If some training objectives have not been met, employers should review the initial training needs. It should be established with the training provider whether the delegate should go on a different type of course and/or the reasons why the objectives have not been covered in sufficient depth. Employers should ensure that employees' training objectives have been met during the training programmes attended. The design and content of courses should be checked on a regular basis, eg annually, to ensure that they are still up to date and take any legislative changes into account.

Stage 5: Record-keeping

4.32 Records need to be kept in order to demonstrate that the workforce has been suitably trained and that their training has been kept up to date. Such information will be required at asbestos licence interviews, carried out by HSE inspectors, as part of the Asbestos Licence Assessment Guide procedure.

4.33 Employees should be given a copy of their training certificate/record. Originals can be kept centrally and copies sent to individual sites. Such information should be carried to site to be checked by visiting Enforcing Authority Inspectors or to accompany the Construction Skills Certification Scheme (CSCS) card. This card is an entry requirement for larger sites managed by members of the Main Contractors' Group (MCG) involved in the CSCS scheme.

4.34 It is the long-term aim to have an industry-wide, recognised identity card for asbestos removal workers. Currently, the different training associations and individual training providers create their own certificate or identity card. Employers should ensure that any such certificate or identity card supplied by a training provider or by a new employee has the following:

- a unique numbering system;
- the card holder's National Insurance number;
- the person's photograph;
- the date(s) of the training course(s) and renewal date;
- the type of course(s) and the modules passed;
- the name, address and contact details of the training provider.

4.35 The materials used for the card or certificate should not be easy to forge.

4.36 In order to build up evidence of worker competence, employers can use logbooks to demonstrate the type of work that the employee has been carrying out and to what standard. The use of such logbooks would be useful for those employees trying to obtain the NVQs in Removal of Asbestos Containing Materials, Level 2. Adequate record-keeping is essential for effective monitoring (see paragraphs 4.38-4.40).

Stage 6: Consolidation of skills and knowledge

4.37 It is essential for recently trained employees, particularly those new to asbestos work, to consolidate their newly acquired skills and knowledge by putting them to use on the job. Supervisors and managers will play an important role in coaching these members of staff by reinforcing good work practices and correcting any bad ones. Where persistent problems occur, re-training may be required. It is important to begin the consolidation process as soon as possible after training has been provided, but certainly within three months. Some form of assessment will be required to gauge how well the employee is performing. Logbooks can be used to record examples of work done which demonstrate the application of specific skills.

Stage 7: Monitoring, auditing and policy review

Monitoring

4.38 To ensure the effective implementation and review of the policy, all aspects of the training programme should be monitored. Supervisors will play an important part in the day-to-day monitoring, but formal monitoring should be the responsibility of senior management. Directors or owners of the company should take an overall interest in and responsibility for the training programme and should monitor its effectiveness. The monitoring arrangements should be set out in the safety policy.

Auditing

4.39 Training courses should be audited in some way to establish that they meet the course criteria set out in this guidance and that syllabi have been delivered effectively.

Policy review

4.40 The training policy, like all health and safety policies, should be reviewed on a regular basis. As annual refresher training is required, it may be appropriate to review whether the training policy is still relevant to business needs on an annual basis. Further guidance on how to monitor and review policies can be found in the HSE guidance booklet *Successful health and safety management*.¹⁹

Further information

4.41 For detailed guidance on syllabi, criteria and assessment, contact any of the training providers on the HSE list of training providers (see www.hse.gov.uk) or contact the ALU.

APPENDIX 4.1: ASBESTOS TRAINING MODULES 1-23 (SCAFFOLDERS 20-23 ONLY): INITIAL TRAINING

Module no	Title
Module 1	<i>Types uses and risks of ACMs</i>
1A	Operatives Types of asbestos fibres – characteristics, uses, identification methods (introduction), nature and levels of risk for different groups of ACMs; history of import, manufacture and installation of different ACMs; types of products that may contain asbestos; likely locations; previous treatment methods covering old asbestos applications; ACMs' friability/conditions when they will release fibres; recognition and need for control; emergency and remedial work
1B	Supervisors As for operative, ACMs – know how the presence of asbestos can be confirmed (bulk sampling and analysis)
1C	Managers/directors and SLHs As for supervisors
Module 2	<i>Health hazards of asbestos</i>
2A	Operatives How fibres cause disease; types of asbestos-related diseases and how related to exposure; medicals under CAWR; need for dust/fibre suppression to control exposure; need for correct use/maintenance of RPE; health effects of smoking and risks of taking home asbestos-contaminated equipment/clothing etc
2B	Supervisors As operatives
2C	Managers/directors and SLHs As operatives plus outline of legal responsibilities (CAWR); civil vs criminal law
Module 3	<i>Legislation</i>
3A	Operatives Duties of the individual; key duties of the employer; overview of licensing framework; control of exposure – as low as reasonably practicable; overview of CAWR; requirements of the ACOP and associated guidance; overview of Waste Regulations ^{20,21} and Environmental Protection Act. ²² Action levels and control limits
3B	Supervisors As operatives, but with emphasis on responsibilities of supervisor
3C	Managers/directors and SLHs As operatives, but with emphasis on management responsibilities; knowledge of which work requires a licence, the types of insurance cover required and sourcing of information on ACMs

Module 4 <i>Site set up, maintenance and dismantling</i>	
4A	<p>Operatives <i>Set up:</i> Need for pre-clean; vacuum cleaners; site layout, including citing of hygiene unit as close to enclosure as possible; optimal positioning of air/baglocks and NPUs; explanation of how NPUs work and the significance of the voltmeter and pressure gauges and what changes in the gauge readings mean; when pre-filters should be changed; strategy for calculating air changes; connection and testing of hygiene unit; construction of enclosures, air/baglocks including possible weather protection; positioning of clear viewing panels; positioning and wording for warning notices and barriers; how to delineate work areas and transit routes; smoke testing and need for witnessing <i>Maintenance:</i> Daily inspections of enclosure (start, middle and end of shift) and immediate rectification of defects; strategy for NPUs to be kept running after stripping finishes for the day <i>Dismantling:</i> Once clearance achieved, spray enclosure with sealant, bag and seal vacuum cleaners, bag other equipment, dismantle polythene and dispose of as asbestos waste; final inspection of area once enclosure and all associated equipment have been removed</p>
4B	<p>Supervisors Recognise which ACMs are not being removed as agreed with client. As 'Operatives' and check certificates for hygiene unit NPU, gas test, clearance in shower and dirty end from previous job, NPUs and vacuum cleaners; how to check for negative pressure in the enclosure; ensure that viewing panels (or other viewing means eg CCTV or webcams) are provided</p>
4C	<p>Managers/directors and SLHs As supervisors</p>
Module 5 <i>Controlled stripping techniques</i>	
5A	<p>Operatives Chapter 7 of this guide in detail, including principles of fibre suppression and control of exposure; equipment – use of, maintenance and cleaning; wet injection and spraying techniques; wrap-and-cut; glovebags; direct vacuuming; LEV (shadow vacuuming); vacuum transfer; air management; preparation time and testing of controls before removal; wetting agent selection, preparation and use; COSHH requirements; anticipated and desired fibre levels and comparison with RPE maximum exposure levels; personal assessment monitoring (principles); access to personal assessment information</p>
5B	<p>Supervisors As for operatives plus equipment inspections and records, fault-finding and solutions. Monitoring for effectiveness of fibre control techniques and recording information</p>
5C	<p>Managers/directors and SLHs As for operatives and supervisors, plus equipment and wetting agent selection; maintenance and training requirements</p>
Module 6 <i>Respiratory protective equipment</i>	
6A	<p>Operatives The circumstances when RPE must be worn which may include: inspection of work area, building and dismantling enclosures, working in enclosure, taking bags to skip; how to inspect, test and wear respirator; need for quantitative face-fit test, a good face seal and the need to be clean shaven; correct storage, battery charging and keeping clean; strategy for changing pre-filters and main filters</p>
6B	<p>Supervisors As for operatives</p>
6C	<p>Managers/directors and SLHs As for operatives</p>

Module 7 <i>Personal protective equipment and clothing</i>	
7A	Operatives The use of the appropriate PPE including: overalls, headgear, footwear and gloves; employer requirements to provide appropriate PPE and employees' obligations to use it; care, wearing, cleaning, decontamination and/or disposal of PPE; not taking contaminated PPE home; transit overalls; when and where PPE should be worn; ensure correct use and maintenance of PPE
7B	Supervisors As for operatives plus PPE use during transit procedures; contaminated clothing and waste; keeping of relevant records
7C	Managers/directors and SLHs As for supervisors, plus knowledge of practical difficulties of wearing PPE, such as heat/cold and laundry requirements
Module 8 <i>Transit procedures and decontamination</i>	
8A	Operatives Personal decontamination procedures for directly connected and remote (transit) DCUs and airlocks including: PPE changing and disposal, showering, colour coding of coveralls, RPE decontamination, cleaning, charging and storage; use of towels; changing and disposal of pre and main RPE filters; decontamination procedures where no enclosure or DCU is required (open sites); common problems with decontamination; cleaning of airlocks and DCUs; emergency decontamination in case of evacuation or accident; what should be in the DCU, ie mirror, soap/shower gel
8B	Supervisors As for operatives, plus common problems and fault-finding with decontamination; air monitoring results in DCUs; inspection and record-keeping; the importance of ensuring that procedures are followed; making time available to allow adequate showering; DCU checks (see Box 8.1)
8C	Managers, directors and SLHs As supervisors, plus interpretation of inspections and audit results; the importance of ensuring that adequate equipment, materials and resources are made available to put the procedures in place
Module 9 <i>Cleaning and clearance air testing</i>	
9A	Operatives Cleaning and clearance requirements, including the need for the four-stage clearance process and associated certificate of reoccupation; visual cleanliness and air testing requirements; methods of cleaning for enclosures, hygiene facilities and equipment; re-cleaning in event of air test failure; cleaning after enclosure dismantling; cleaning in the event of an emergency or enclosure/equipment damage
9B	Supervisors As for operatives; the requirements of analysts before clearance inspection and sampling
9C	Managers/directors and SLHs As for operatives and supervisors

Module 10 <i>Plant and equipment (using demonstration of equipment)</i>	
10A	Operatives Equipment components; equipment use and maintenance including: NPUs, Type H vacuums and injection equipment (RPE covered separately)
10B	Supervisors Equipment components; equipment use and maintenance including: NPUs and monitors, Type H vacuums and injection equipment; citing and daily maintenance of the hygiene unit; record-keeping (RPE covered separately)
10C	Managers/directors and SLHs Outline of components, use and maintenance of NPUs, Type H vacuums; use and maintenance of injection equipment; citing and daily maintenance of hygiene unit; record-keeping (RPE covered separately): need for new injection equipment to meet PAS 60 standard.
Module 11 <i>Waste management and disposal</i>	
11A	Operatives Bagging, sealing and cleaning; transportation through baglock and airlock; storage of asbestos waste; correct loading of skip/van
11B	Supervisors Outline of Waste Regulations; use of consignment notes; registration of carriers; role and powers of environment agencies; transportation of dangerous goods; bagging, sealing and cleaning; transportation through baglock and airlock; storage of asbestos waste; correct loading of skip/van
11C	Managers/directors and SLHs As supervisors
Module 12 <i>Emergency procedures</i>	
12A	Operatives What to do in the event of major and minor injuries or illnesses occurring inside 'live' enclosures; what to do in the event of fire, or some other hazardous release such as toxic gas or radioactive dust occurring inside or outside enclosure; what to do if leak of asbestos is found outside the enclosure; what to do if power on power-assisted respirator fails while inside 'live' enclosure; what to do if the NPUs stop working; what to do if there is complete loss of electrical power; what to do if loss of water supply to hygiene unit
12B	Supervisors As operative, but confirming the responsibility of the supervisor to ensure that suitable emergency procedures are in place to cope with the failure of any control measures or the injury or ill health of a worker inside contaminated areas
12C	Managers/directors and SLHs As operative and to confirm they are all in place and appropriate to specific site and circumstances; assessing the competence of operatives and supervisors, importance of auditing and monitoring work activities; notification of asbestos work
Module 13 <i>Non-asbestos hazards</i>	
13A	Operatives Site safety procedures; permit-to-work systems; entry and exit in case of fire; location of possible site hazards; emergency procedures in case of fire, electric shock, burns, hazardous substances, solvents etc; care of injured casualty; manual handling, noise, vibration and falling object protection, slips, trips and falls, eg working from scaffolding
13B	Supervisors As operative, plus electrical checks for DCU (see Box 8.1)
13C	Managers/directors and SLHs As supervisors, except electrical checks

Module 14 <i>Fault-finding</i>	
14A	Operatives How to spot problems with wetting of ACMs, RPE, airlocks, enclosures and hygiene unit
14B	Supervisors Work practices – how to spot problems with wetting of ACMs, RPE, airlocks, enclosures and hygiene unit; method statements; RAs; signs; record-keeping and fault reporting procedures
14 C	Managers/directors and SLHs As ‘Supervisors’ Note: Managers/directors need an overview of fault-finding while SLHs need a far more detailed session at the level of a supervisor
Module 15 <i>Roles and responsibilities</i>	
15A	Operatives To adhere to the principles of their training; to work to the RA and POW; when work should be halted because it does not match the POW; to work safely and not to put others at risk from their acts or omissions; to wear PPE and RPE correctly and to report any defects; to understand why they should not take short cuts
15B	Supervisors To ensure everyone complies with regulations, ACOPs, guidance and follows the RA and POW. If the work method has to change - work is stopped and reassessed. The RA and POW are amended and personnel informed of the changes in writing; to ensure all personnel are instructed, face-fitted and have received a medical; all equipment is inspected and tested; all daily inspections are carried out; all documentation is available and up to date; the importance of being on site for key stages of the work and their crucial role in directing the work and monitoring standards of work
15C	Managers/directors and SLHs As above and to ensure that all activities and training meet the legal requirements
Module 16 <i>Site inspections and record-keeping</i>	
16A	Operatives Purpose of site inspections, site auditing and record keeping; role of inspector/auditor; responsibilities of operatives; reporting faults and other problems
16B	Supervisors As operative, plus criteria, for site inspections; actions in event of faults; record-keeping; scope and nature of records, use of typical record and reporting systems
16C	Managers/directors and SLHs As operative and supervisor, plus retention of data, including exposure records and health surveillance; methods and criteria; interpreting and monitoring records; fault-finding and solutions; data handling and the need for site audits

Module 17 <i>Management systems and monitoring</i>	
17A	Operatives Maintenance and monitoring of control measures; controlling exposure to asbestos; ensuring that equipment functions correctly; pre-start setting-up; barriers and signs; construction and testing of enclosures and airlocks; site monitoring; use/testing of negative pressure equipment and ventilation and air management systems; correct maintenance of all site equipment - following manufacturers' operating instructions, including the correct maintenance and monitoring of the following control measures: enclosures, external services, NPUs, wet strip units, mobile generators, water supply, heating appliances, PPE, RPE, any dust suppression equipment, tools and DCUs
17B	Supervisors As for operatives, plus site supervision and record-keeping of work in progress; method statements; POWs; monitoring and auditing work in progress
17C	Managers/directors and SLHs As supervisors
Module 18 <i>RAs and POWs</i>	
18A	Operatives Introduction to RAs (know what they are for) – understanding the main points, right to see significant findings; requirements to follow RAs and risks/penalties if not followed; the meaning of the control limits and action levels
18B	Supervisors As operative, plus carrying out RAs and developing a POW (instruction and exercise); changes and amendments to RA/POW; seeking advice and informing of changes; notification to HSE when change is significant and what is a significant change
18C	Managers/directors and SLHs As operative and supervisor, plus notification to enforcing authority, review of RA/POWs, record-keeping and storage of RA/POW
Module 19 <i>Information, instruction and training</i>	
19A	Supervisors How to implement and monitor on-job training (consolidation); how to assess the competence of employees; the types of training available and how to choose the right course; TNA in practice; recognising the need for additional training when new equipment or work methods are introduced
19B	Managers/directors and SLHs As for supervisors
Module 20 <i>Scaffolders: Health risks and avoidance of exposure</i>	
20	All levels How to avoid exposure when working near asbestos; types of asbestos fibres - characteristics, uses, identification methods (introduction); nature and levels of risk for different groups of ACMs; types of products that may contain asbestos; likely locations; how fibres cause disease; types of asbestos-related diseases and how they are related to exposure
Module 21 <i>Scaffolders: Use of RPE, PPE and emergency decontamination procedures</i>	
21	All levels How to recognise that exposure has occurred; how to deal with minor and gross contamination; decontamination procedures; what RPE and PPE to wear and when

Module 22 <i>Scaffolders: Roles and responsibilities</i>
All levels Legal responsibilities of individuals, employer and management; the role of the asbestos removal company and SLH; the information that should be shared between all parties
Module 23 <i>Scaffolders: Management systems</i>
Scaffold supervisors/managers/directors RA and POW; introduction to what enclosures are for and how they are built; monitoring of site conditions; site set-up; emergency procedures

APPENDIX 4.2: ASBESTOS TRAINING MODULES 24-27: PRACTICAL TRAINING

Module no	Title
Module 24	<i>Decontamination and transit procedures</i>
	The design, connection and citing of a DCU; explanation of preliminary and full decontamination procedures and use of RPE and PPE; practising use of decontamination and transit procedures in a hygiene unit that is plumbed in and fully operational and mock airlock/enclosure
Module 25	<i>Use and maintenance of RPE</i>
	How to ensure the RPE is suitable for the user; how to fit RPE on site; how to check faulty RPE and what to do if a fault is found; the components of each type of RPE; certification and documentation; suitable storage; requirements of daily and monthly inspections
Module 26	<i>Construction of enclosures and airlocks</i>
	Construction of an enclosure on a pre-erected 50 mm x 50 mm timber framework using 1000 gauge polythene sheeting, adhesive tape and staples; construction of a three-stage airlock system on a pre-erected 50 mm x 50 mm timber framework using 1000 gauge polythene sheeting and adhesive tape; construction of a three-stage airlock system using metal and/or plastic framework; construction of a proprietary airlock system, eg a 'transtent'; the use and location of viewing panels; the use and location of warning signs; smoke testing to determine integrity; the construction and location of baglocks
Module 27	<i>Use of controlled stripping techniques</i>
	The connection and use of an injection kit to wet pipe insulation, including the demonstration and use of an effective needle system eg PAS 60 equipment – they should be able to determine that needles are the only effective way to wet insulation as a result of this session and the importance of adjustable liquid flow rates; shadow or trace vacuuming – practice the removal of a tile or duct panel using this technique

APPENDIX 4.3: COURSE CRITERIA FOR PEOPLE CARRYING OUT OR SUPERVISING ASBESTOS REMOVAL OR ANCILLARY WORK

A4.3.1 The following criteria were drawn up after consultation with the asbestos training providers known to HSE (see www.hse.gov.uk). Courses should meet these criteria. During a licence application or renewal interview an ALPI will question any applicant's training that does not meet these criteria.

Course content

A4.3.2 Modules for initial training can be found in Appendices 4.1 and 4.2. In using these modules you are likely to achieve compliance with the training requirements of *Work with asbestos insulation, asbestos coating and asbestos insulating board. Control of Asbestos at Work Regulations 2002. Approved Code of Practice and guidance*.¹² Courses should be role-specific, ie operatives and supervisors should not be mixed together to avoid the more experienced personnel becoming bored and new operatives being afraid to ask questions.

A4.3.3 There is no reason why additional modules cannot be added to courses, but those listed in Appendices 4.1 and 4.2 are the minimum required for each role. The numbers of the modules that have been passed should be clearly stated on the training certificate or card.

Duration of courses

A4.3.4 A day's training means **at least six hours**, not including breaks.

Duration:

- New operatives' course: three days' minimum (includes one day of practical sessions).
- New supervisors' course: three days' minimum (includes one day of practical sessions).
- Managers' and directors' course: two days' minimum.
- Scaffolders' course: 0.5 day minimum.
- Scaffolding supervisors' course: 0.5 day minimum (additional to the 0.5 day scaffolders' training).
- Managers and directors of scaffolding companies - one day minimum.
- Supervisory licence holders' course: 2-4 days (includes one day of practical sessions). People may be exempt from certain modules if they hold relevant BOHS qualifications. A TNA should identify the outstanding modules that should be covered in addition to these qualifications.
- Refresher training for all roles: one day minimum (except for scaffolders and scaffold supervisors: 0.5 day).

Tutor to delegate ratios

A4.3.5 The HSL report recognised that there was a need for a high tutor to delegate ratio for practical hands-on training, such as use of decontamination procedures. As a result, the following maximum ratios have been agreed for initial courses:

- Theory-based sessions for all courses: 1 tutor to 12 delegates.
- Practical sessions: 1 tutor to 6 delegates.

As refresher training is mainly classroom-based, the ratio of tutor to delegates can be raised up to 15.

Assessment of attainment levels

A4.3.6 It is important to know what knowledge and skills the delegate has before starting the course, so there can be some measurement of improvement over the period of the course. You should provide the results of any TNA to the training provider to assist them in adapting the course to make it as relevant as possible to the delegates. There are various ways of assessing what the delegates have learnt. Verbal feedback can be provided to the delegates as the course progresses, especially during practical sessions. In addition, it is expected that a test will be provided at the end of the course. It is expected that the delegates should achieve 80% or more in the test to obtain a pass mark. Oral tests should be offered to people with learning difficulties. Special needs should be identified before the start of the course to adapt the training programme if necessary.

A4.3.7 Any delegate who fails the test should have some means of appealing against the result and be allowed to retrain and/or resit the test within an agreed period of time. In the meantime, such a person should not be allowed to work on site in areas where it is foreseeable that the relevant control limit will be exceeded. It is no longer acceptable to have an 'attendance-only' certificate.

Practical sessions

A4.3.8 There will be more of a practical bias on courses for new operatives, new supervisors, scaffolders and SLHs because there are certain practical skills that need to be acquired. Modules 24-27 listed in Appendix 4.2 are of a practical nature. The term 'practical' in this context means that delegates are shown how to do something and are then required to practise what they have been shown to acquire a new skill, eg fitting RPE. Such a practical session can only provide a simulation of site conditions. Consolidation of skills on site is essential.

A4.3.9 The core subjects that must be provided in the form of a practical module (in accordance with the ACOP)¹² are:

- the use of decontamination facilities;
- the use and fitting of RPE;
- the use of controlled stripping techniques (wet fibre suppression techniques and other controlled stripping methods, such as shadow vacuuming);
- construction of enclosures and airlocks;
- waste removal procedures (by demonstration).

A4.3.10 Practical training should not be carried out in live working areas that may be contaminated with asbestos.

APPENDIX 4.4: CARRYING OUT A TNA

A4.4.1 The most important step in choosing training is determining what is needed and ensuring that it is conducted as early as possible. Often, employers opt for too little, too late when training their employees – this leaves employees with incomplete or inappropriate skills. Conducting a TNA will allow employers to determine how many of their employees need to be trained, and what they need to be trained in.

A4.4.2 A full scale TNA is a long-term project and will require the assistance of an experienced training consultant who will use a combination of research techniques such as observation, questionnaires, interviews and focus groups. These techniques enable the investigation of both the individual needs of the employees and the organisational needs of the company. However, the following four steps provide helpful information that will allow you, as employers of asbestos removers, to determine the training needs of your employees. This is particularly useful since TNAs are required for all workers who are employed to work with asbestos insulation, asbestos coating or AIB.

Step 1 Perform a gap analysis

A4.4.3 This process will assess current skills and desired skills to establish the extent of the skills gap, if any.

- Identify the staff to be trained. What duties do the staff perform? Which of these involve hazards and which require training?
- What is the experience, education and technical level of the trainees identified?
- Have these trainees received training before? Does this previous training meet their skills?
- Is there legislation which affects the training to be given? (All asbestos operatives and ancillary staff who work with asbestos insulation, asbestos coating or AIB must have their training needs assessed before starting work).
- What will the training accomplish?

Step 2 Identify causes of problems and/or opportunities

A4.4.4 It is unlikely that all the training needs that emerge from the first step can be addressed immediately. So, the needs will have to be prioritised. Prioritisation can be assisted by asking the following questions:

- Does the need apply to all your employees or just those who work in particular areas?
- Does the need apply to one or several individuals?
- Does this type of training involve some form of knowledge or skill that may be difficult for your employees to learn?
- Is there legislation requiring the need to be met? If so, the training will need to be provided regardless of the number of people it applies to, or the knowledge/skill level of the training.

Step 3 Evaluate current training

A4.4.5 Once training needs and priorities have been established, a training plan will have to be prepared. The current training arrangements should be assessed.

A4.4.6 If there is a formal training department this will have to be evaluated to

see if the needs identified by Step 1 are being met. Even if there is not a formal training department, there are likely to be some employee training materials such as manuals and guidance. These materials can be integrated into any new training solution. Review the procedures you already have in place, and be prepared to adapt them to your new training needs.

Step 4 Provide training and conduct an evaluation

A4.4.7 Once the needs have been prioritised and the training provided, the TNA needs to be evaluated by conducting the four steps again. So, the TNA process is a cycle, which needs to be continually addressed, as demonstrated in Figure 4.1.

A4.4.8 The above steps only provide a guide to conducting a TNA. A full-scale TNA is likely to require assistance from a qualified trainer and will be more thorough.

Figure 4.1 TNA flow chart

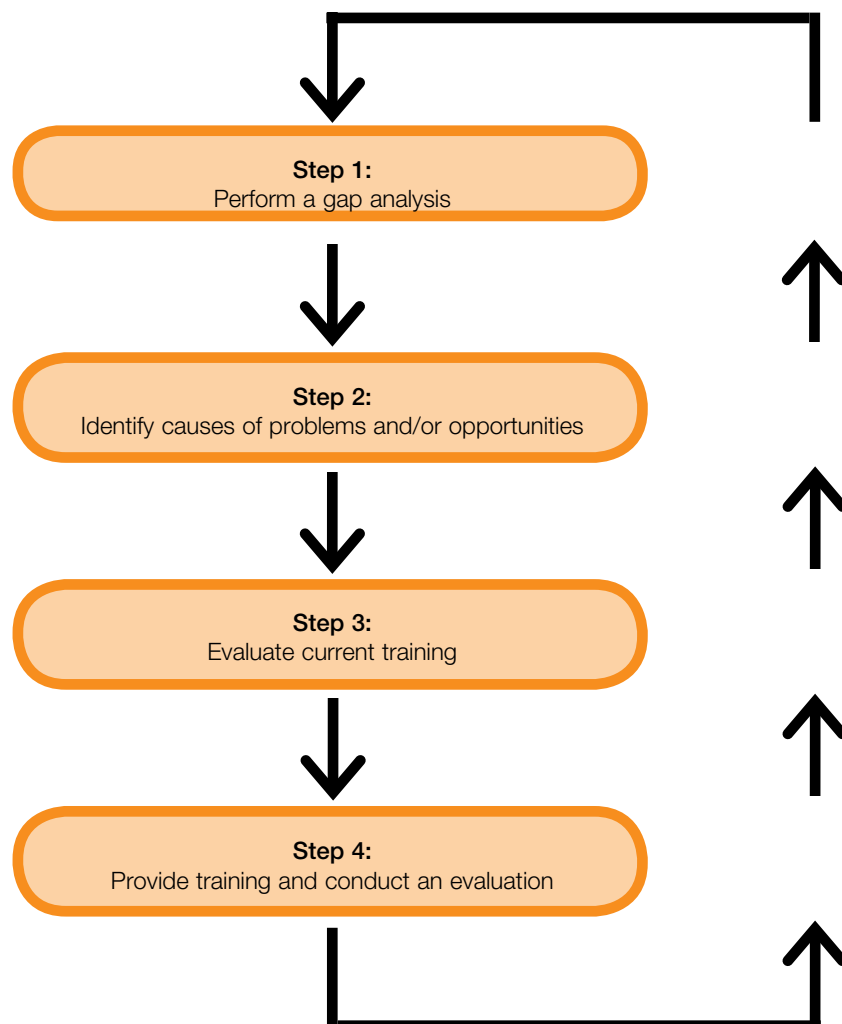

Chapter 5: PPE for work with ACMs



Summary

- RPE:
 - RPE must be matched to the work, wearer and level of exposure;
 - wearers should be face-fit tested to ensure they have the correct device;
 - RPE should be kept clean, maintained and periodically tested.
- Coveralls:
 - should be worn whenever there is a possibility of contamination with asbestos fibres;
 - can be non-disposable or disposable;
 - disposable should be Type 5 category 3.

Contents

Introduction 77

RPE 77

Why should RPE be provided? 77

When should RPE be provided? 77

Control measures to apply before resorting to RPE 77

Specific requirements for RPE use 77

RPE and CE-marking 78

How to select suitable RPE for employees 78

Expected exposure concentrations 79

Protection factors 79

Face mask fit testing 79

Qualitative fit test 80

Quantitative fit test 80

Care, maintenance and testing of RPE 83

Looking after RPE 83

Air quantity and quality 84

RPE training for employees, including supervisors 84

Supervision 84

Some common misuses of RPE when working with asbestos 84

Coveralls 86

Introduction

5.1 This chapter explains PPE, in particular RPE, its provision, use and maintenance.

RPE

Why should RPE be provided?

5.2 Asbestos workers are potentially most at risk of developing asbestos-related diseases. Removal processes by their nature disturb and release asbestos fibres. If the release is uncontrolled or poorly controlled, airborne fibre concentrations can be extremely high (eg >100 f/ml). Even where effective controls have been implemented, airborne fibre levels can still be in excess of the control limit. That is why it is important that everyone who works with asbestos should take the strictest precautions to reduce exposure to asbestos fibres as low as is reasonably practicable. RPE plays a crucial part in the control regime. Its main purpose is to reduce worker exposure (ie the number of fibres inhaled) when fibre levels in the air around the worker are still significant and cannot be reduced further by other means.

When should RPE be provided?

5.3 CAWR requires employers to do all that is reasonably practicable to prevent exposure to asbestos fibres, or where prevention is not possible, to reduce exposure to the lowest possible level. RPE must be provided if, despite the precautions taken, exposure to asbestos fibres is liable to exceed the control limits laid down in the Regulations. The RPE must reduce the exposure as low as is reasonably practicable.

You should not use RPE as your only control measure as RPE can only reduce exposure, not stop it

You must reduce asbestos fibre concentrations in air to a minimum before using RPE

Control measures to apply before resorting to RPE

5.4 Exposure to asbestos should be prevented or reduced to as low as is reasonably practicable by engineering controls before RPE is employed. Engineering controls include: enclosure and extraction of the work area; wet removal methods; wrap-and-cut and glovebag techniques; and shadow vacuuming. These methods are described in detail in Chapter 7.

Uncontrolled dry removal processes are unacceptable

Specific requirements for RPE use

5.5 The law states that RPE used at work must:

- be **adequate** and provide the wearer with effective protection;
- be **suitable** for the intended use;
- be 'CE'-marked;
- be selected, used and maintained by properly trained people;
- be correctly maintained, examined and tested;
- be correctly stored; and
- have records kept of selection, maintenance and testing.

Adequate

RPE is considered adequate if it can provide the level of protection required to reduce the exposure to comply with the law.

Suitable

RPE is considered suitable if it is adequate **and** is matched to the wearer, the task and the working environment, such that the wearer can work with minimum impediment and without additional risks due to the protective equipment.

RPE and CE-marking

5.6 The RPE provided for work with asbestos must be marked with a CE symbol. The CE-marking means that the RPE meets minimum legal requirements for its design and manufacture by conforming to a European Standard. The CE-marking does not indicate that it is automatically suitable for a particular type of use.

How to select suitable RPE for employees

5.7 RPE needs to be selected very carefully and in consultation with employees. Employers should also discuss it with the safety representative if there is one.

5.8 The equipment will need to be matched to the type of work to be done, including the working environment, the wearer, other PPE in use and the exposure concentrations (expected or measured). This means it will need to:

- provide adequate protection (ie reduces the wearer's exposure to asbestos fibres as low as is reasonably practicable, and anyway to below the control limits) during the job in hand and in the specified working environment (eg confined area or at height);
- if fan-assisted, provide clean air at a flow rate and duration that conforms to the manufacturer's minimum specifications;
- if air-fed, provide clean air at a flow rate that at least conforms to the minimum recommended by the manufacturer;
- properly fit the wearer;
- be reasonably comfortable to wear;
- be properly maintained; and
- not introduce additional hazards that may put the wearer's health and safety at risk.

When choosing RPE, employers will need to consider:

- the expected concentrations of asbestos fibres in the air;
- the protection factor values of different types of RPE (see Tables 5.1 and 5.2);
- the potential for oxygen deficiency and/or the presence of other hazardous substances (eg solvent vapours, carbon dioxide and carbon monoxide) within the work environment. Employers should be aware that particulate filters used for protection against asbestos fibres will not protect against oxygen deficiency, gases or vapours. Work in oxygen-deficient atmospheres must comply with the requirements of the Confined Spaces Regulations 1997;¹⁵ carbon monoxide can be produced from petrol or diesel-powered heaters and equipment;
- the kind of work involved, eg more strenuous jobs may need a greater air supply;
- the temperatures at which people will be working;
- the facial characteristics of the wearers (eg beards, sideburns, glasses etc);
- the medical fitness of the people needing to wear the equipment; employees need to be physically and mentally fit to work wearing RPE (and PPE),

particularly inside an enclosure, as the CAWR medical examination is not a fitness-for-work examination;

- the length of time the person will have to wear the equipment;
- how comfortable it is and whether people will wear it correctly for the required length of time;
- whether the job involves extensive movements, restrictions and/or obstructions which need to be overcome;
- the need to communicate verbally during work;
- the effects of other PPE and other accessories on RPE (eg unmatched goggles may affect the face seal provided by the face mask); and
- jewellery or other adornments (eg piercing) worn by the wearer, which may interfere with the fit of the face mask.

5.9 More details on these aspects can be found in the HSE guidance *Respiratory protective equipment at work: A practical guide*.²³

Expected exposure concentrations

5.10 The level of expected exposure should be established in the RA. The results from previous air monitoring can be used to assist the assessment. Some data on the likely fibre concentrations for a range of asbestos jobs is given in Tables 1.1 and 1.2. The data can be used as a guide, but it does not constitute an RA.

Protection factors

5.11 The expected exposure level is used to determine the minimum protection factor required by the RPE. This parameter should be considered first in the selection process.

5.12 Tables 5.1 and 5.2 list various types of RPE and the respective protection factors (PFs). RPE with the highest PF should be considered initially. Then consider whether this RPE is suited to the nature of the job, work-related factors, wearer's facial characteristics, medical fitness and comfort. Using this process, select the most suitable type of RPE for the job. The process is demonstrated through a worked example in Table 5.3. The chosen RPE must also be adequate for any unexpected short-term high exposures. The reasons for selecting a particular type of RPE should be recorded in the RA.

5.13 In practice, asbestos workers are likely to wear only a limited range of RPE. A disposable type is likely to be used for various tasks including site pre-clean, site set-up, inspection (four-stage clearance or initial), enclosure dismantling, waste handling outside the enclosure, DCU cleaning, and scaffolding erection; and a power-assisted full-face respirator will be worn when entry into a live enclosure occurs. In these situations FFP3 disposable masks and power-assisted full-face equipment fitted with a P3 filter should be used respectively. However some people may prefer to use half-masks rather than disposable equipment, and powered hoods or blouses or air-fed equipment may be used in some circumstances in place of power-assisted full-face masks (see paragraph 5.20).

Face mask fit testing

5.14 The performance of tight-fitting face masks depends on achieving a good contact between the wearer's skin and the face seal of the mask. As people's faces have a range of shapes and sizes it is unlikely that one particular type, or size of face mask, will fit everyone. Inadequate fit will significantly reduce the protection provided to the wearer. To make sure that the selected face mask can provide adequate protection for the wearer, a fit test should be carried out. The test should be carried out as part of the initial selection of the RPE. There are two types of fit tests: qualitative and quantitative fit tests (**Note:** fit tests should not be confused

with the 'fit check', a procedure specified by the manufacturer which is used to verify that a good seal has been obtained each time the respirator is used (see paragraph 5.18)).

Qualitative fit test

5.15 Qualitative fit testing is a simple pass/fail test based on the wearer's subjective assessment of the leakage, via the face seal region, of a test agent. These tests are relatively simple to perform and are suitable for half-masks and filtering facepiece (disposable) respirators. A qualitative fit test is **not** suitable for full-face RPE.

Examples of qualitative fit test methods:

- method based on bitter or sweet-tasting aerosol;
- method based on odour compounds.

Quantitative fit test

5.16 Quantitative fit testing provides a numerical measure of the fit and generates a 'fit-factor number'. These tests give an objective measure of face fit. They require specialised equipment and are more sophisticated than qualitative methods. These methods should be used for full-face RPE and can be used for half-masks and disposable respirators.

Examples of quantitative fit test methods:

- laboratory test chamber;
- particle counting device.

5.17 Further details on RPE fit testing can be found in the document *Fit testing of respiratory protective equipment facepieces*.²⁴ This can be downloaded from the HSE website.

Table 5.1 Respirator selection chart for protection against asbestos in air

PF	Filtering half-mask BS EN 149	Valved filtering half-mask BS EN 405	Filtering half-masks without inhalation valves BS EN 1827	Half-mask BS EN 140 and filter BS EN 143	Full-face mask BS EN 136 and filter BS EN 143	Powered hoods and filter BS EN 146 BS EN 12941	Power-assisted masks and filter BS EN 147 BS EN 12942
40					Mask + P3	TH3 hoods, blouses + P3	TM3 full-face mask + P3
20	FF P3	FF P3	FM P3	Mask + P3		TH2 All types of face pieces + P3	TM2 All types of face pieces + P3

Table 5.2 Breathing apparatus (BA) selection chart for protection against asbestos in air

PF	Fresh-air hose BA BS EN 138/269	Light-duty compressed airline BA masks BS EN 12419	Light-duty compressed airline BA hoods, helmets, visors BS EN 1835	Constant flow compressed airline BA hood BS EN 270/271 Mask BS EN 139	Demand flow compressed airline BA mask BS EN 139	Self-contained BA (SCBA) BS EN 137
2000					Positive demand full-face mask	Positive demand full-face mask
200				Suit		
40	Full-face mask Hood	LDM3	LDH3	Hood Blasting helmet Full-face mask	Negative demand full-face mask	Negative demand full-face mask
20		LDM1 LDM2	LDH2	Half-mask		

Table 5.3 Worked example

Work:	Removal of asbestos insulation from a boiler house
Type of asbestos:	Representative samples taken from the lagging to be removed and the occupier's documentation about it indicate that the lagging contains chrysotile (white asbestos) only
Control limits:	0.3 f/ml for 4-hour time weighted average (TWA) and 0.9 f/ml for 10-min TWA as prescribed in CAWR
Proposed type of removal:	Well-conducted, controlled wet stripping using manual tools. Representative core samples taken after the wetting process at an earlier job indicated that it is unlikely to hit a dry patch. Same procedure will be conducted to ensure similar situation in this work. Wetting to be done using injection needles, wetting agents and water
Amount to be removed:	8 m ² of asbestos-containing lagging material
Likely residual fibre in concentration in air:	Up to 1 f/ml (Table 1.1) and this figure agrees with the exposure monitoring results obtained during similar work last month

Table 5.3 Worked example (continued)

Work activity:	Have to work around and in between pipes. Removal workers will have to pass in between pipes and girders (both vertically and sideways). Adequate time and person resources have been planned in for stripping, cleaning and decontamination activities. The effort required – moderate work. Working on a cold plant. The work environment is not a confined space and will contain normal levels of oxygen. No need to use solvents, glues etc
RPE wearers:	Clean shaven except for one person who has beard; no unusual facial marks; no spectacle wearers
Other PPE:	Type 5, category 3 coverall (see paragraph 5.35) to protect against asbestos penetration. Gloves and safety boots in accordance with RA requirements
Protection required:	Minimum protection required from suitable RPE to reduce exposures to the control limit of $1/0.3 = 3.3$ (ie likely residual fibre concentration in air divided by 4-hour TWA control limit). This calculation indicates that it would be possible to use devices with a PF of 4. However, the law requires that inhalation exposure to asbestos fibres is reduced to the lowest level reasonably practicable. Therefore, it is necessary to consider devices which could offer the best possible protection
Selection of suitable RPE:	<p>From Table 5.2 – Types of RPE which offer highest PF (2000) are self-contained breathing apparatus (SCBA) with positive-demand full-face mask and compressed airline-breathing apparatus (CABA) with positive-demand full-face mask</p> <p>(a) SCBA is not suitable because it will not last for more than 15 minutes of actual stripping work. Safe usable time for SCBA will include time required for decontamination and exit to a safe area. SCBA would be too bulky to use in the likely restricted space; it will introduce unnecessary strain on the wearer and may cause other safety-related accidents</p> <p>(b) In this situation it is not reasonably practicable to use CABA because air supply hoses can become entangled during use. This may introduce tripping hazards and may present considerable secondary exposure problems during disconnection to enter the decontamination area. During the decontamination of hoses, asbestos on hose protective coverings may contaminate the decontamination area. For these reasons it is considered that CABA is not suitable for the work to be undertaken</p> <p>(c) The next choice of device is respirators. Respirators with the highest PFs (Table 5.1) are non-powered full-face mask with P3 filter(s), TH3 powered hoods and TM3 power assisted devices with full-face masks and P3 filter(s). A non-powered device would be uncomfortable and would place demand on the user's lungs when compared to a powered device. So a TM3 power-assisted respirator with full-face mask and P3 filter(s) would be the choice for those without beards. This RPE, when used in conjunction with a suitable RPE programme, should reduce the exposure concentration to below 0.02 f/ml. This concentration is near the clearance level</p> <p>(d) All our wearers, except the person with the beard, were quantitatively fit tested for a power-assisted respirator with full-face mask (TM3) – model 123 made by ZZ Ltd. In this work situation, the person with the beard could be provided with a TH3 powered hood. If the power to the device fails completely during use, the wearer should be able to exit the work area quickly and without significant danger to life or health</p>

5.18 To obtain adequate performance during use, the selected RPE should be worn correctly every time. This means that the user should carry out a fit check on every occasion that a mask is worn to ensure that a good fit has been obtained. Beards, sideburns and even stubble or wearing glasses will affect the face seal of tight-fitting face masks which rely on a close contact between face and mask. Employees wearing RPE relying on a tight face fit should be clean shaven. The expected level of workplace protection provided by suitable RPE is shown by the PF values in Tables 5.1 and 5.2.

5.19 A repeat fit test should be conducted where the wearer:

- is changing to a different model of RPE or different sized face mask;
- loses or gains weight;
- undergoes any substantial dental work;
- develops any facial changes (scars, moles etc) around the face seal area; or
- if the company's health and safety policy requires it. It is recommended that employers have a specific policy on frequency of repeat fit testing, eg every one or two years.

5.20 For workers who cannot wear a tight-fitting facepiece, equipment that does not rely on a good face seal for protection should be provided, eg powered or air-supplied hoods, and powered or air-supplied blouses. For workers who normally wear glasses, there are two further options: wearing contact lenses inside a standard full-face mask or to wear a full-face mask which permits the fixing of special frames inside the facepiece.

Care, maintenance and testing of RPE

Looking after RPE

5.21 The RPE must be checked to ensure it is clean and in good working order before it is given to the wearer, and before it goes back into storage. Badly maintained RPE will not provide adequate protection and the wearer's health will be put at risk. Before use, checks, where appropriate, should be made on:

- the condition of the head harness, and the facepiece including seal and visor;
- the condition of the inhalation and exhalation valves, where fitted. For example dirty, curled-up or cracked valves will not perform properly and will severely compromise the protection provided;
- the condition of any threaded connectors and seals;
- the condition and type of filter(s), that they are 'in-date' and fitted properly;
- the battery charge/condition;
- the airflow rate for power-assisted and powered respirators compared with the manufacturer's specification – before the device is used;
- whether the RPE is complete and correctly assembled; and
- any additional tests in accordance with the manufacturer's instructions.

5.22 In addition to the pre-use checks detailed above, all RPE (except the disposable type) should be more thoroughly examined and tested, by trained personnel, before it is issued to any wearer for the first time and at least once a month to make sure that it is working properly to its design specification. A record of inspection, examination, maintenance and defects remedied must be kept for five years. Only proprietary spare parts should be used.

5.23 The manufacturer of RPE should give instructions on its cleaning and maintenance. The procedures should be followed. After each use, RPE (except the disposable type) should be decontaminated, cleaned, disinfected, inspected and placed in suitable storage specifically provided for that purpose.

Air quantity and quality

5.24 Where breathing apparatus is used, the flow rate and pressure of the air supply should be checked at the start and end of each shift. Also, wearers should check these at regular intervals during the shift. Air supplied to breathing apparatus (BA) should meet minimum quality requirements. These are given in British Standard BS EN 12021.²⁵ The RPE or air compressor supplier should be able to advise on how to meet these requirements.

Do not modify any form of RPE without the knowledge and consent of the manufacturer

RPE training for employees, including supervisors

5.25 Employees should be given adequate instruction, information and training on the following:

- how to fit and use the RPE correctly;
- why they must wear the RPE correctly and the importance of fit testing for the initial selection of suitable equipment and pre-use fit-checking each time it is worn;
- why they should never take off and/or put down RPE in a contaminated area, except in a medical emergency;
- how to recognise a reduction in air flow and what to do if it happens;
- why a particular type of RPE has been selected, and what it can and cannot do;
- the manufacturer's instructions on the use and maintenance of the equipment;
- how to clean contaminated RPE when leaving the work area; and
- when not in use, where and how to store the RPE.

5.26 Employees should receive regular refresher training (at least once a year) on the use of RPE. **It should not be assumed that, because workers have worn RPE before, they will always use it properly.**

Supervision

5.27 The competent supervisor should monitor the use of RPE to ensure that it is worn properly. For instance, the supervisor must make sure that wearers never:

- misuse equipment (examples of misuse and common mistakes are listed below); or
- remove their RPE in a contaminated area – not even for a moment, except in an emergency (eg medical, accidental damage to RPE).

5.28 It should be standard practice for supervisors and wearers to check that the RPE is in good working order (before wearing it) and that it is being worn correctly.

Some common misuses of RPE when working with asbestos

5.29 The examples below indicate some of the very serious misuses of RPE. Misuses of this kind will always result in reduced protection and unnecessary, and preventable, exposures to asbestos fibres. These misuses invalidate the suitability of RPE and constitute a failure to comply with CAWR.

Figure 5.1 Misuse of RPE



Figure 5.2 Misuse of RPE



All types of RPE

- Wearing of disposable respirators, half and full-face masks by people with facial hair which prevents an adequate seal being achieved.
- Wearing safety goggles or spectacles which are not compatible with the disposable respirator or a half-mask. Incompatible goggles will prevent an adequate seal being achieved.
- Failing to ensure that the RPE fits the wearer.
- Working in a contaminated area while the respirator is left hanging around the neck.
- Using the RPE if it is dirty, damaged or incomplete.
- Failing to properly maintain the RPE.
- Leaving the mask lying around in the workplace – dust will get inside and the wearer will breathe it in the next time it is put on.
- Wearing the coverall without the hood in position (see Figure 5.1).

Disposable respirators

- Wearing the respirator upside down.
- Failing to adjust the nose clip to obtain a good face-fit and face seal.
- Not using the two head straps correctly.
- Working in a contaminated area while the respirator is left hanging around the neck or placed on top of the head.

RPE with full-face masks

- Failing to adequately tighten all the head harness straps.
- Wearing ordinary spectacles with a full-face mask. There are special frames which can be fitted inside the mask which do not interfere with the face seal.
- Wearing the head harness over the hood of the coverall – this can cause slippage of the mask and loss of the face seal (see Figure 5.2).
- Failing to ensure that the correct filter is fitted in the filter housing, or that seals/O-rings are in place and correctly seated.
- Failing to ensure that filters are present in their housing.
- Failing to tighten the breathing hose to the face mask and filter housing.
- Failing to test the airflow.
- Failing to replace worn and distorted masks.
- Failing to test the voltage and capacity of batteries, and to replace inadequate ones.
- Keeping working if the fan stops or the flow rate falls – leave the work area immediately.
- Using filters not approved for the device.

Coveralls

5.30 Coveralls should be worn whenever an RA indicates there is a possibility of contamination with asbestos fibres. Therefore they should be worn during:

- preparation of the work area including pre-clean and construction of the enclosure (unless the preparation work does not involve any potential for asbestos contact or contamination);
- the preparation and use of controlled stripping equipment;
- any work involving the removal or repair of asbestos;
- the four-stage clearance; and
- the dismantling of the enclosure and residual clean up.

5.31 Coveralls may also be needed for other activities, where the potential for contamination exists, eg inspecting roof voids or undercrofts when preparing tenders.

5.32 Non-disposable (eg cotton) and disposable coveralls can be used. Disposable coveralls tend to be more popular as there are few laundries now accepting asbestos-contaminated items for washing. It is also easier to double bag disposable overalls and dispose of them as asbestos waste, either on site, where there are facilities, or at base. Cotton coveralls should be decontaminated in a specialist laundry after use (see paragraph 8.43).

5.33 Disposable overalls vary significantly in quality and, although they are generally only used for one shift or less, it is important that good quality disposable overalls are used. Poor quality overalls:

- tear easily, allowing contamination of the operative's body; and
- allow permeation of fibre through the intact material.

5.34 Contamination inside the coverall increases the potential for operator exposure and further spread of asbestos. Disposable overalls should therefore be selected that are robust enough and large enough to allow free movement throughout the enclosure. It is good practice to wear one size too big, as this can reduce ripping and tearing at the seams.

5.35 A Type 5, category 3 disposable coverall will provide such protection. Type 5 relates to draft standard BS EN ISO 13982-1,²⁶ and category 3 (CE complex; risk of serious or mortal danger) is in accordance with the Personal Protective Equipment (PPE) Regulations 1992.²⁷

5.36 The coveralls should have elasticated cuffs or be sealed with tape. In addition, coveralls should be worn in such a way as to reduce the ingress of dust inside the garment. The ingress points are at the head and feet. The coverall hood should be worn **over** the straps of the RPE and the coverall legs should be worn **over** footwear, ie do not tuck legs into the boots as dust and debris will get in at the top.

Chapter 6: Enclosures for work with ACMs



Summary

- The planned work area, immediate surrounding area and waste/transit routes should be checked to see whether a pre-clean is needed.
- **Enclosures**
 - Are required unless the level of risk is likely to be low, the location is remote, or an enclosure is not practical.
 - Should be constructed of 1000 gauge polythene.
 - Should be connected directly to the DCU where possible.
 - Should be placed under negative pressure.
 - Should have viewing panels (size at least 600 mm x 300 mm).
 - Should have a sacrificial flooring.
 - May require additional protection, eg for weather protection, or be fire-retardant.
- **Airlocks and baglocks**
 - Should be of an appropriate size for the number of personnel and amount of equipment (dimensions at least 1 m x 1 m x 2 m (height)).
 - Should have a viewing panel on the inner stage (size at least 600 mm x 300 mm).
- **NPU**s
 - Should provide a slight negative pressure of 5 Pa.
 - Should provide a constant flow of fresh air through the enclosure.
 - Should be sufficient in quantity and placed correctly to prevent 'dead spots' and 'short-circuiting'.

Contents

Introduction 89

Definition and use 89

When is an enclosure required? 89

Preliminary planning 91

Enclosure design and main features 91

Enclosure size 91

Sealing the enclosure 92

Enclosure extraction (negative pressure) 93

Enclosure access 93

Viewing panels 96

Occupied buildings 96

Securing external enclosures 97

Site preparation and construction of enclosures 97

Site preparation and pre-clean 97

Construction of the enclosure 98

Air extraction equipment 100

Testing, monitoring and maintenance 105

Visual inspection 105

Smoke testing 106

Differential pressure monitors 106

Viewing panels 107

Air monitoring 107

Testing and maintaining air extraction equipment 107

Dismantling and disposal 108

Emergency procedures 109

Figure 6.1 Enclosure with three-stage airlock



Figure 6.2 Work without an enclosure



Introduction

6.1 Enclosures are a fundamental component in the control of asbestos materials during removal work. This chapter explains the function and purpose of enclosures and gives practical advice on their design, construction and use during work with asbestos. Enclosures are normally required to:

- prevent the spread of asbestos (CAWR, regulation 15); and
- prevent the exposure of other people (employees and others) (CAWR, regulation 10) who may be affected by the work.

Definition and use

6.2 An enclosure is a physical barrier employed around the asbestos work area which will contain asbestos dust and waste arising from the work and which will also prevent the spread of asbestos materials to the surrounding environment. It is designed to prevent the spread of airborne fibres and dust and also to prevent the spread of surface contamination during all the activities associated with asbestos removal, including waste handling and bagging, and cleaning.

6.3 Access to the enclosure is regulated through entrance and exit openings (known as airlocks, see Figure 6.1). The airlocks are an essential feature of the enclosure, allowing the controlled movement of personnel, waste and equipment in and out of the work area and also enabling the decontamination of personnel, equipment and waste items on exiting the unit. Airlocks are also used for changing, where transiting procedures are employed (see paragraphs 8.13-8.15). The enclosure and airlocks should be airtight and under mechanical extraction ventilation.

6.4 Enclosures by design and function will lead to increased amounts of dust and debris inside the area. Anyone entering or working inside an enclosure must wear suitable protective clothing and RPE, and must thoroughly decontaminate themselves on leaving the enclosure. Further information on personal protection and decontamination procedures is given in Chapters 5 and 8 respectively.

When is an enclosure required?

6.5 Work on the most hazardous forms of asbestos (ie those which require a licence to work on: asbestos insulation, asbestos coatings and AIB) will normally require an enclosure. These ACMs include asbestos thermal insulation (such as boiler and pipe insulation, and sprayed asbestos applied for fire protection, anti-condensation and acoustic control), and AIB products such as ceiling tiles or panels or boards containing asbestos. The enclosure will be required irrespective of the nature of work location (such as in buildings, ships and other structures) or the size of the premises.

Enclosures are needed to control the spread of airborne or surface contamination. Whenever this is likely, an enclosure is needed

6.6 Enclosures are also necessary in situations where, although the work may have primary controls (eg glove bags), the consequences of a control failure would be significant in terms of contamination or risk, so there needs to be secondary containment. This means that an enclosure will be required in most situations, but there will be some exceptions, including for ACMs which normally require a licence (see paragraphs 6.7-6.8).

6.7 Enclosures are not generally required for work with non-licensed asbestos products, such as cement materials, eg corrugated roofing sheets and building panels (see Figure 6.2). Asbestos cement items normally present lower risks. Precautions for work with these materials are described in the HSE guidance booklet *Working with asbestos cement*.³ However, there may be occasions when an enclosure is needed for asbestos cement. If the asbestos cement is extensive and difficult to remove, resulting in much breakage and debris, or the work is close to occupied or sensitive areas, then an enclosure may be needed.

6.8 Enclosures would also not be necessary for licensed products in certain circumstances. For example where there are practical difficulties in constructing an effective enclosure or the location is very remote. In addition, an enclosure will not be required for minor work with licensable materials, eg certain types of short duration or low risk work where an asbestos licence is not needed. Details on these types of activities and the necessary precautions are given in the HSE guidance booklet *Asbestos essentials task manual: Task guidance sheets for the building maintenance and allied trades*.² *Asbestos essentials* is primarily targeted at tradespeople carrying out one-off jobs. If licensed asbestos removal contractors carry out similar one-off tasks, these procedures are appropriate. However, if the work areas are larger or the task is repetitive, an enclosure will be required. An enclosure would also not normally be required in dealing with minor contamination situations where the asbestos is only present as loose debris or dust. An enclosure would also not be expected in external situations involving building rubble, soil or contaminated land.

6.9 The scenarios where an enclosure may not be required can be summarised as follows. These will be determined in the RA for the work, taking into account the likely risks, and the practicalities and costs involved. Enclosures may not be required if:

- the level of risk is low because the operations are very small scale and of short duration. When considering the level of risk you should consider the potential for fibre release and the spread of surface contamination;
- the location is extremely remote, where the risk to employed people or members of the public is negligible;
- the work is at height and an enclosure is not practical due to the height or complexity of the structure (eg pipework in the open air at high level), or its exposure to severe weather conditions;
- it is a situation where there are practical difficulties in obtaining an effective seal on the structures, eg soffits around building roofs;
- cleaning up minor contamination or external contamination.

Remoteness by itself is not a reason to justify the absence of an enclosure

6.10 If an enclosure is not a reasonably practicable option, remember that a key component in the control of asbestos and in the controlled movement of personnel, equipment and waste will be absent. The absence needs to be compensated for and alternative arrangements employed. In such cases, the boundaries of the work area should be clearly marked by suitable warning notices and by physical obstructions such as ropes or barriers. Such segregation measures should be placed at a distance away from the work and not immediately next to it. In addition, in the absence of an enclosure, particular emphasis has to be placed on work methods and procedures which minimise dust generation and prevent the spread of contamination. Reassurance air sampling may also be required. There will still need to be arrangements to regulate the movement of personnel equipment and waste from the designated work area and to carry out preliminary decontamination procedures and waste bagging. Full decontamination facilities (ie a hygiene unit) will

be necessary in most cases (the exceptions are likely to be *Asbestos essentials*² scenarios and cleaning up contamination). A certificate of reoccupation will also be required in most situations (again with similar exceptions) although clearance air monitoring will not be necessary in external locations (see paragraph 6.67).

Preliminary planning

6.11 The enclosure is a key feature in the control of asbestos during removal work. It has to be designed properly and it has to operate effectively for the duration of the work. These are matters to be considered in the very early stages of work planning and they should form part of the RA process. The enclosure will be deployed in many different situations and conditions so, while there are many common features of the enclosure, irrespective of where it is used, it has to be designed specifically for the particular circumstances of the individual job. The factors to be considered for all uses are as follows:

- clearance of the work area;
- removal of 'mobile' items;
- the need for a pre-clean;
- the size and shape of the work area;
- the enclosure will be as airtight as possible;
- plant is switched off (eg boilers) after liaison with the client;
- there will be sufficient and uniform negative pressure (without short circuiting) within the enclosure and airlocks;
- there will be sufficient air movement through the enclosure;
- there will be safe and easy access for personnel, equipment and waste;
- the enclosure will be robust for the conditions;
- security and prevention of damage;
- provision of viewing panels;
- actions to take in an emergency;
- the need for fire prevention materials (eg fireproof polythene).

6.12 There are other matters which may have to be considered in some situations, such as:

- work in occupied buildings;
- securing external enclosures.

Enclosure design and main features

6.13 An enclosure typically consists of the items in Figure 6.3.

Enclosure size

6.14 The enclosure should be designed around the location of the asbestos to be removed and the access requirements. It should be big enough for the work activity and there should be reasonable working space. The dimensions should take account of the number of workers involved and the size and shape of the items or materials to be removed and the need for any plant or equipment to be used. Items to consider include lengths of pipework, and plant such as scissor lifts or platforms. The enclosure should not be oversized, as it increases the spread of asbestos and the size of the area to be cleaned. It also increases the ventilation requirement.

6.15 Enclosures may either make use of parts of the existing building structure or be self-supporting temporary structures purpose built around the asbestos working area. Existing rooms or walls, ceilings and floors can be used where possible to provide part or all of an enclosure. The surfaces of the enclosure, irrespective of the composition, should be smooth and impervious. If any existing surface is

unsuitable, eg it is rough, damaged or friable, it should be pre-cleaned and then lined with a material such as polythene sheeting. The integrity of the enclosure must also be maintained as work progresses. For example when AIB ceiling tiles are removed opening the ceiling void. The 'void' will become part of the enclosure. It will need to be smoke tested and the area volume included in the ventilation calculation. It may be possible to seal such areas as work progresses. However these areas will need to be cleaned and subject to clearance procedures.

Sealing the enclosure

6.16 The enclosure should be effectively sealed and as airtight as possible. All leaks should be identified and sealed. Sealing should be undertaken at all joints and corners, particularly in purpose-built structures and at all windows, doors, ventilation grilles, airbricks, inlets, exhausts as necessary. Particular attention should be paid to closing any gaps or holes around pipes, ducts, conduits, structural or other items (including inside cupboards or units) that pass through to adjoining rooms or floors. Openings should be sealed using a combination of materials such as tape, proprietary sealing compounds (eg expanding foam) (see Figure 6.4) and impervious sheeting. Foam should be trimmed to size after setting. If complete sealing is difficult to obtain, then additional controls should be employed. These can include mini-enclosures within large enclosures, glove bags and enhanced negative pressure.

Figure 6.3 Schematic diagram of the main elements of an enclosure

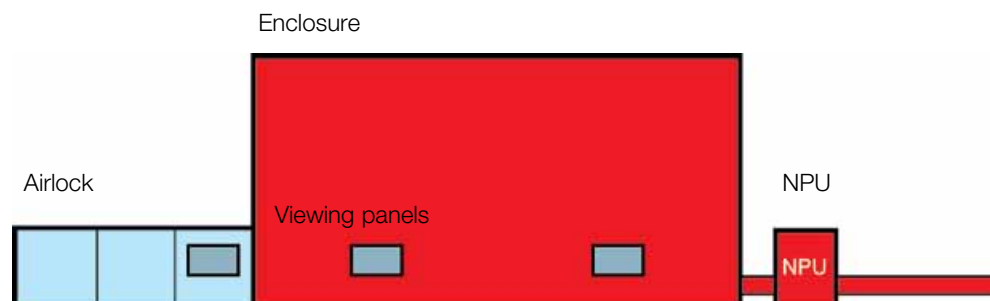

Figure 6.4 An enclosure sealed with expanding foam



Note: The use of certain foams and adhesives in very confined spaces, on hot pipework or close to the breathing zone may cause high concentrations of harmful vapours and should be avoided. The use of any sealant or adhesive should be considered in an RA to establish the risks to health and the appropriate controls and protective equipment. Also if some foams were to remain after completion of the work, it may have implications for fire regulations.

The enclosure should be constructed before any work on the ACMs, including placing of injection needles, is carried out

Enclosure extraction (negative pressure)

6.17 There should be sufficient negative pressure (ie mechanical extract ventilation) within the enclosure and the pressure should be as uniform as possible throughout the unit. Air extraction should not be seen as an alternative to a well-sealed enclosure. Its functions are to provide additional control if there are accidental leaks and to control air movement during personnel and waste transfers to and from the enclosure.

Figure 6.5 An NPU



6.18 The pressure differential will depend not only on the extracted air rate from the enclosure, but also on the physical size and shape of the structure, the extent of leakage (ie the effectiveness of the sealing) and external weather conditions, eg a change in wind direction can positively pressurise an enclosure. Where large extensive plant or long stretches of pipework are to be stripped of asbestos, it may be appropriate to sub-divide the space into a number of smaller enclosures, rather than to treat it as a single unit. It may be difficult to achieve good negative pressure for extremely large enclosures (eg those used in power stations), although the NPUs (see Figure 6.5) will help to achieve some airflow near work areas, even if not providing good negative pressure.

6.19 Also, where the work area is complex or consists of a series of rooms (eg in office blocks or hotels) there will be potential difficulties in achieving a uniform negative pressure. Again, in these cases there should be several smaller enclosures. In some situations, it will be beneficial to have smaller working enclosures built around the specific items to be stripped. In situations where negative pressure is difficult to achieve, over-extraction may compensate but the extraction level should not damage the integrity of the enclosure (see paragraph 6.47). In addition, if stripping involves opening up other parts or sections of the premises, eg in removal of ceiling tiles or dividing walls, the ventilation rate should be calculated on the basis of the final enclosure volume, ie the initial area and the ceiling void. Air movement is discussed in more detail in paragraphs 6.41-6.47.

6.20 Air movement in the enclosure should be designed to ensure that there is uniform airflow as far as possible in all areas. NPUs and supplementary air inlets should be located to achieve good flow and to avoid dead spots (see paragraph 6.42). Air movement should be checked during the smoke test (ie checking that smoke is cleared efficiently from all areas of the enclosure) and by using smoke tubes and/or differential pressure monitors.

Figure 6.6 DCU attached directly to an enclosure



Enclosure access

6.21 All enclosures should have means of access for personnel, plant and equipment, and the removal of asbestos waste. Openings for these purposes need to be constructed in a manner which prevents asbestos dust escaping into the general environment. Asbestos workers should enter the enclosure from the hygiene facility, which should be attached via a short intervening space or tunnel to the enclosure wherever practicable. This is shown in Figure 6.6. This is the preferred arrangement. Where the hygiene facility cannot be positioned close to the enclosure, a transiting system is required. Transiting systems are much more complex and should be avoided where possible. However there will be many

Figure 6.7 An airlock used in transiting



occasions when their use is necessary. In transiting systems, workers will enter the enclosure via a three-stage airlock. The airlock is shown in Figure 6.7. Information on the procedures for transiting and for using hygiene facilities is given in Chapter 8.

6.22 Enclosures should be designed and constructed with separate arrangements for the removal of asbestos waste. A system of airlocks (called baglocks) similar to the transit facilities can be used for the removal of waste asbestos from the enclosure. The design of the baglock system is shown in Figure 6.8. In those circumstances where a separate airlock and baglock system cannot be employed, a hybrid arrangement should be used. The design of the hybrid system will depend on whether the hygiene unit is connected directly to the enclosure or whether a three-stage airlock is involved (ie transiting). The various options are shown in Figures 6.9 and 6.10. The arrangements and procedures for cleaning, labelling and transferring waste bags are described in Figure 6.8 and Box 7.6.

Figure 6.8 Typical design of three-stage baglock for removal of waste from an enclosure

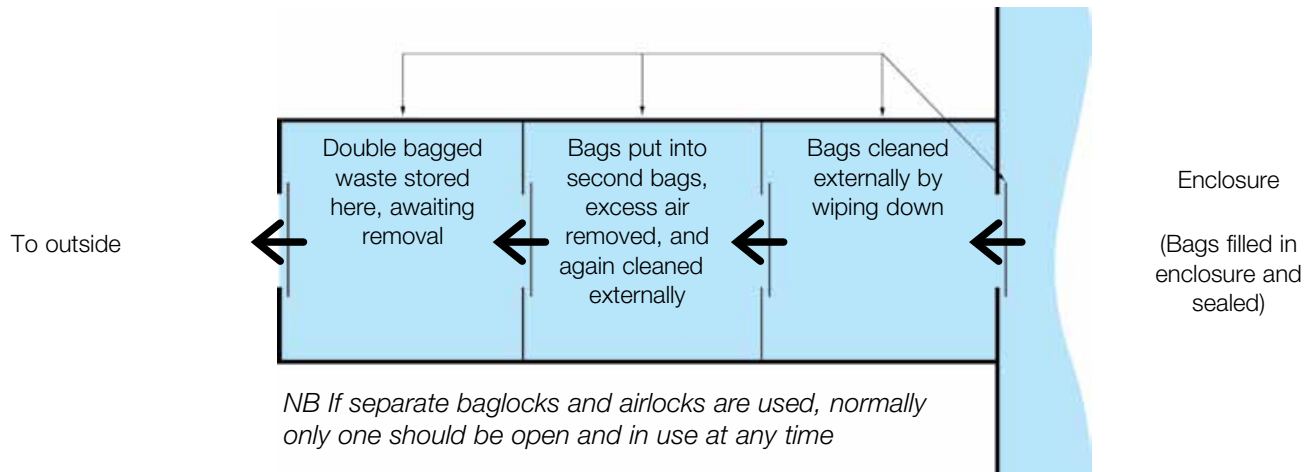

Figure 6.9 Airlock/baglock arrangement where the enclosure is directly attached to the DCU and there is limited space

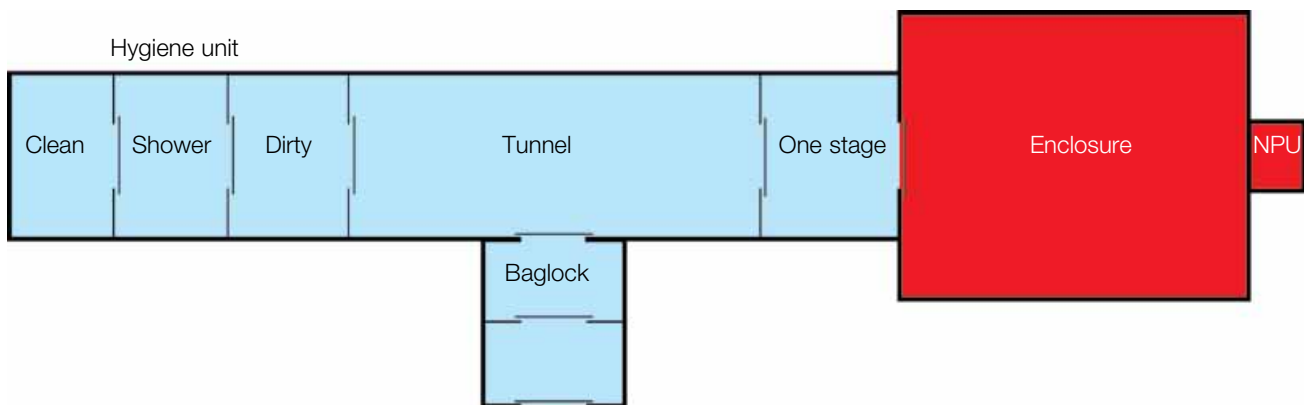

Figure 6.10(a) Airlock/baglock arrangement where transiting is involved and there is limited space

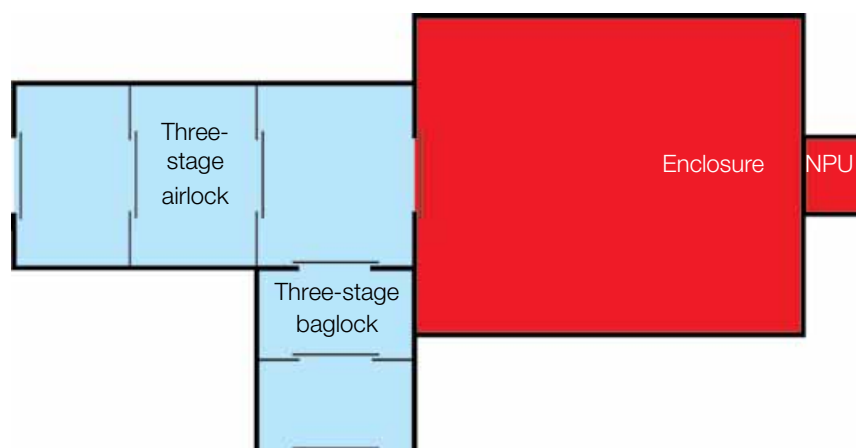
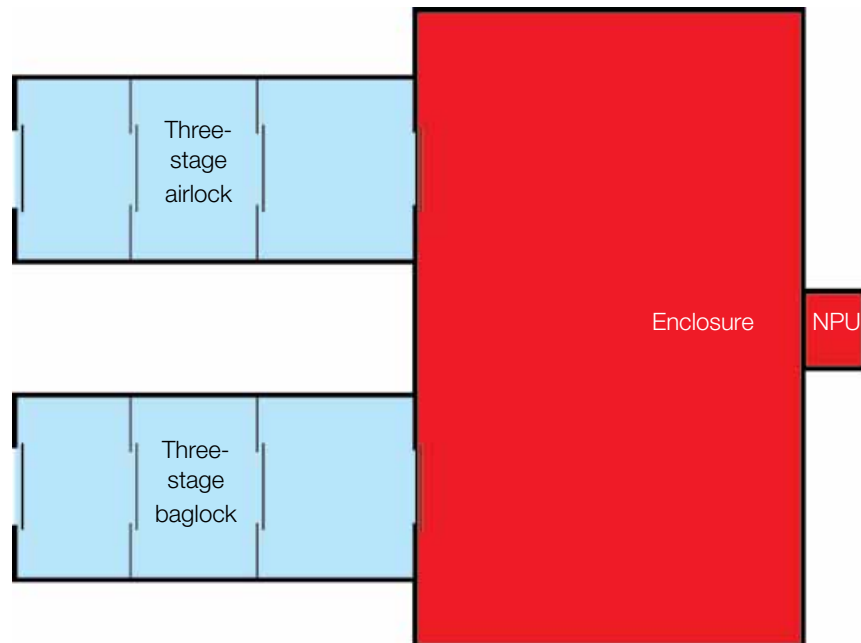

Figure 6.10(b) Airlock/baglock arrangement where transiting is involved and there is sufficient space



Asbestos waste bags should not be taken through the hygiene facility

Figure 6.11 Viewing panel



Viewing panels

6.23 Suitable clear perspex 'viewing panels' must be included in the walls of the enclosure so the site supervisor can see what is going on inside without having to enter (see Figure 6.11). This helps ensure that the method detailed in the POW is being followed. The number and location of these panels will depend on the location, size and complexity of the enclosure (see paragraph 6.37). Viewing panels should be employed in the inner stage of airlock and baglocks. Where viewing panels are impractical, organisations should use alternative methods to observe and monitor progress within the enclosure. Camera (eg CCTV) and computer webcam systems can be used. Miniature colour cameras/transmitters are now available and can be linked to a receiver and monitor or TV. Hard-wired systems are also available. Cameras can be placed in appropriate locations. The types of circumstances where camera systems should be used include underground locations, multiple-floor buildings, existing buildings where panels cannot be installed, enclosures where work location is obscured or remote from the viewing panels. Cameras should be protected for ease of cleaning (eg sheeted over).

Occupied buildings

6.24 If other parts of the building are to be occupied during asbestos removal then particular care and attention will be needed to ensure that the work does not present any risk to the building occupants. Additional safeguards and checks will be required. Visual inspections and airborne sampling outside the enclosure will be necessary to confirm the effectiveness of the control regime (see paragraph 6.56 and Box 6.1). It will also be necessary to identify and prevent or resolve any additional hazards introduced by the enclosure, eg if it obscures or blocks any fire exits. Where this is unavoidable, alternative arrangements should be made and clearly communicated to the building occupants and the asbestos removal workers. Fire alarms should be able to be heard from inside the enclosure.

6.25 It will also be necessary to ensure that occupancy or operation of any processes or building services does not adversely affect the performance of the enclosure. Checks should be made to ensure that mechanical air movement within the building does not compromise the negative pressure inside the enclosure, and also that process emissions are not drawn into the enclosure. For example movement of lifts will cause changes in air pressure. The effects of any building processes and the impact of air conditioning, location of lift shafts or air heating systems also need to be considered. Take care to ensure that existing ventilation systems are not contaminated, eg through inappropriate siting of NPU discharges near to ventilation intakes.

Securing external enclosures

6.26 Enclosures must always be properly secured to prevent toppling or falling over. This is particularly relevant for external units which are subject to the vagaries of the weather. Enclosures should be securely attached to the building itself or onto scaffolding. Consider the security of the enclosure to ensure unauthorised personnel do not enter.

Site preparation and construction of enclosures

Site preparation and pre-clean

6.27 Before any work starts (including erecting the enclosure), the DCU should be set up and operational. An assessment should have been completed to establish the PPE and RPE required for the initial preparation work and construction of the enclosure. The proposed work area should be inspected and checked to prepare for the removal work. The main purpose of the inspection is to identify the need for a pre-clean, prepare the site for work (eg by sheeting or removing items, ie a 'soft strip'), and to deal with matters which may cause difficulties in obtaining clearance certification (eg remaining ACMs, wet floors etc). The site pre-work inspection should be performed in the areas where clearance will be required, ie the planned enclosure area, the relevant surrounding places such as transit and waste routes, and the area immediately next to where the enclosure will be located.

6.28 If there is any evidence of minor ACM debris or dust then a pre-clean should be undertaken (but note 6.30 and 6.31 regarding significant contamination). All the loose material should be cleaned up before the enclosure is constructed. The pre-clean should be undertaken using appropriate dust suppression and control measures, including vacuuming with a type H vacuum cleaner, surface wiping, temporary encapsulation with polyvinyl acetate (PVA), tape or cling film, spray wetting and bagging. It is also advisable to carry out a pre-clean if there is non-asbestos dust and debris present. This material can be disposed of as normal waste. Otherwise once the work starts, the material will be considered as asbestos and will have to be removed as hazardous waste (see paragraphs 7.87-7.101).

A pre-work visual site inspection should be carried out to determine the need for a pre-clean of the area to be enclosed and immediate surrounding areas

6.29 The work area should be free from items of plant, equipment and furniture as far as possible. All mobile or portable items should be removed before the enclosure is constructed. Any items remaining, eg plant or electrical equipment should also be pre-cleaned and then protected or covered with polythene sheeting and securely taped to complete the seal to prevent contamination. If there are boilers, or similar plant incorporating flues, inside the enclosure, the flues should be sealed to prevent the spread of asbestos. The inclusion of live operating plant

within the enclosure will only be allowed in exceptional circumstances (see paragraphs 7.72-7.80). However, if its inclusion is unavoidable, other factors, eg combustion air requirements on active boilers will need to be considered. Similarly, floor surfaces or areas which may be difficult to decontaminate (eg earth floors, behind and below radiators and pipes) or will generate dust during cleaning (eg concrete) should be pre-cleaned and then protected.

Construction of the enclosure

6.30 The enclosure should be designed and constructed so that asbestos materials are not disturbed until it is complete. This is particularly important where there is extensive contamination of the floor and other surfaces.

The hygiene unit should be set up and fully operational before work starts. This includes any work involved with erecting the enclosure and pre-cleaning asbestos or suspect asbestos contamination

6.31 In situations where the work is being undertaken in premises where there is significant contamination (eg due to an incident) and the enclosure cannot be built to encompass the material, then the loose visible asbestos dust and debris and other items should be removed before the enclosure is constructed. The pre-clean should be done using appropriate dust suppression and control measures (see paragraph 6.28).

6.32 Construction and composition of the enclosure will depend on various factors, including the extent of use of the existing building structure, the duration of the job and the location of the work. Where it is possible and feasible, the existing parts of a building may be used. This can have benefits in time and possibly in reducing the potential for leaks. All openings (vents, doors, windows, holes etc) will have to be sealed. However, using an existing building may present practical issues in terms of siting ventilation plant and airlocks, and in the provision of viewing panels.

6.33 The most widely used form of enclosure is a self-supporting temporary unit built to accommodate the work area. These consist of a frame to which sheeting material is securely fixed. Polythene sheeting is one of the most widely used materials for enclosures, providing a flexible, impervious and easily erected barrier. It needs to be thick enough to withstand the wear and tear of the job. For most situations, opaque sheeting of nominal 1000 gauge (250 microns) should be sufficient. Where there are fire hazards, eg in power stations or from process plant, orange fire-retardant polythene should be used. In exposed locations, polythene sheeting may not have sufficient strength, so alternative materials such as polyvinyl chloride (PVC) sheet reinforced with woven nylon mesh can be considered. Where solid barriers are needed, suitable panels or wooden board can be used, lined internally with polythene sheeting.

6.34 The most widely used method of supporting the sheeting material is by timber framework. The size of the timbers used in the supporting framework will vary depending on their unsupported length, but they need to be of such dimensions to provide adequate fixing and support for the sheeting material. Timber width of 50 mm x 50 mm should be sufficient for internal work. Timber should also be clean. The sheeting should be secured to the timber using staples, tape and spray tack. Scaffold frameworks with internally fixed scaffold boards may also be used if they are rigidly connected to the structure or properly designed to be free-standing. Proprietary designed frameworks of metal or plastic pipe, angle, channel etc, can also be used.

6.35 If a scaffold framework with internally fixed boards is used, the sheeting material should be fixed to the inside of the supporting framework. Where a timber framework is used, the sheeting can be attached to either side of the timber. But, note the following points:

- if it is attached to the outside, asbestos fibres may be retained on or behind the framework, so it needs to be either protected against contact with asbestos (eg by taping up the timber/sheeting joins) or the framework and its interface with the sheeting scrupulously decontaminated after use;
- If the polythene sheeting is attached to the inside of the timber, it will need reinforcing, as this is an inherently weaker attachment under negative pressure. More timber should be used in the framework and there should be a greater frequency of staples; the staples should be taped over (using fabric tape) and there should be continuous use of fabric tape at the timber/polythene contact. This arrangement eliminates the potential for dust and debris to be trapped between the timber and sheeting.

6.36 All joints in the sheeting material need to be adequately sealed. Where adhesive tape is used to seal joints on polythene sheeting, it is preferable to apply it to both sides of the joint. Vinyl tape is suitable where an enclosure is only expected to be used for a relatively short period, but if enclosures are to be left in position for a longer period, fabric-based tape (eg 75 mm width polycloth) is more effective.

6.37 The enclosure should contain a sufficient number of viewing panels (and/or CCTV or webcam systems) to allow all parts of the enclosure to be visible from the outside. The clear plastic panels should be inserted into the sheeting during construction. Panels should be taped on both sides. Panel size should be at least 600 mm x 300 mm unless it is impractical and the panels should be located at a convenient height for viewing (eg about 1.5 m from the floor surface).

***The airlocks and baglocks should be at least
1 m x 1 m x 2 m (height)***

6.38 Airlocks and baglocks should be as big as possible to allow the necessary changing, cleaning and transfer activities for workers and waste items and bags. The airlocks and baglocks should be at least 1 m x 1 m x 2 m (height). This is a minimum size. They will have to be bigger in situations where larger items of waste, such as sections of piping, ducting or board, are being removed. Where space is restricted in one direction, eg along a corridor, the airlocks and baglocks should be extended in the other direction (eg 0.8 m x 2 m x 2 m). Separate airlocks and baglocks should be used where space allows.

Figure 6.12 Flap arrangements for airlocks



6.39 Airlocks need to be constructed with access openings between each compartment which prevents asbestos dust passing from one compartment to the next. This is usually achieved by cutting vertical slits in the sheeting and by fixing polythene sheets across the opening (see Figure 6.12). This vertically shaped opening is then reinforced at the top. The vertical sheet needs to be placed on the enclosure side of the partition with an adequate overlap so that air can move inwards but outward air movement is restricted. Smoke testing will demonstrate that this is effective. The bottom of the inner flaps should be weighted down to improve control of airflow by the addition of a timber or metal bar, or a length of chain which allows flexibility in all directions. As airlock flaps are used frequently, they should be made from heavy gauge material such as nominal 1000 gauge sheeting. Various proprietary designs of airlock are available, but some types do not permit the flow of an adequate supply of replacement air. Where these designs are used, separate means of providing replacement air may be needed (see paragraph 6.42). An adequate supply of replacement air into the enclosure is essential (see Figure 6.14). The outer compartment should be fitted with a further

vertical sheet (a security sheet on the outside) which is used to cover over the entrance at the end of the shift. It should be taped back onto the roof area when the airlock is being used.

6.40 The floors of enclosures need to be covered in an impervious material unless the existing floor, on which the enclosure is erected, has an impervious surface which can be thoroughly cleaned after asbestos removal work is completed. Floor coverings may become slippery. If polythene is used, it can be covered with hardboard, or similar material, to minimise this risk. But, where hardboard or similar materials are used, they need to be disposed of as asbestos waste.

The floor of the enclosure should be covered in an impervious layer

Air extraction equipment

6.41 Whatever the type of enclosure, it is important to remember that no construction method will give an absolutely airtight seal and that some degree of leakage will always be present. For this reason, mechanical extract ventilation needs to be applied to maintain the air pressure inside the enclosure slightly below atmospheric pressure (known as negative pressure). This ensures that the airflow through any leaks in the enclosure will be inwards rather than outwards, so that asbestos dust is contained within the enclosure. It is necessary to supply sufficient make-up air to replace the extracted air. This is normally achieved by allowing air to enter the enclosure in a controlled manner through the airlocks. In this way, the ventilation of the enclosure is regulated and a supply of clean air for the asbestos workers is assured.

6.42 The location of the air extraction unit (also called the NPU) needs to be considered to ensure effective airflow management through the enclosure and airlocks. In principle the NPU should be located opposite the airlocks. The ideal position is shown in Figure 6.13. However the exact location will depend on several factors, including the layout and shape of the enclosure and the accessibility or suitability of walls for siting equipment. Examples of good and poor airflow management are given in Figures 6.14 and 6.15. The airlock alone may supply sufficient fresh air for a small or simple enclosure, but for larger or complex premises, additional air inlets may be required. In such circumstances, engineering or ventilation advice should be sought. These air inlets should have filtration (pre-filter) in them and be sealed if the enclosure is left overnight with the NPUs turned off. The location of these inlets also needs to be properly considered to ensure airflow management is not undermined or short-circuited. To ensure sufficient air distribution within the enclosure, it may also be necessary to duct the exhaust air from further inside the enclosure. This is particularly important if the airlock and extract unit are to be sited close to one another.

6.43 The NPU should normally be located outside the enclosure with only the pre-filter visible from the inside. However, this will depend on access and available space. If flexible ducting is required inside the enclosure between the main HEPA filter unit and the pre-filter, it may become damaged, allowing the pre-filter to be bypassed. In such circumstances, this flexible hosing should be protected and regularly inspected.

Figure 6.13 Ideal NPU position

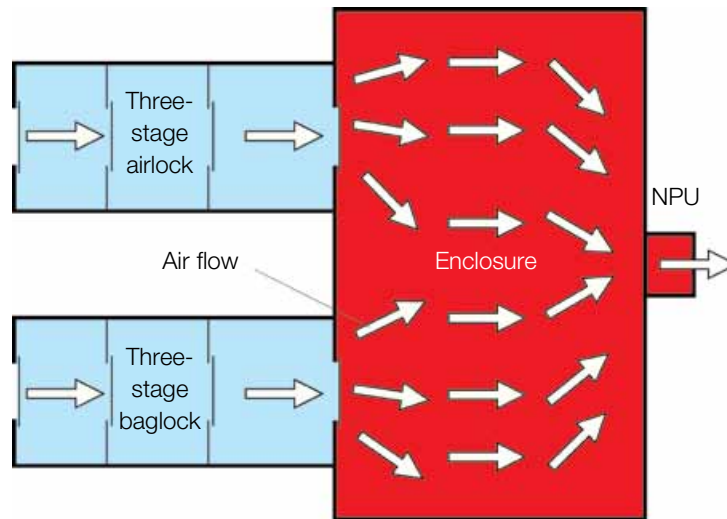

Figure 6.14 Examples of good airflow management in different shaped buildings

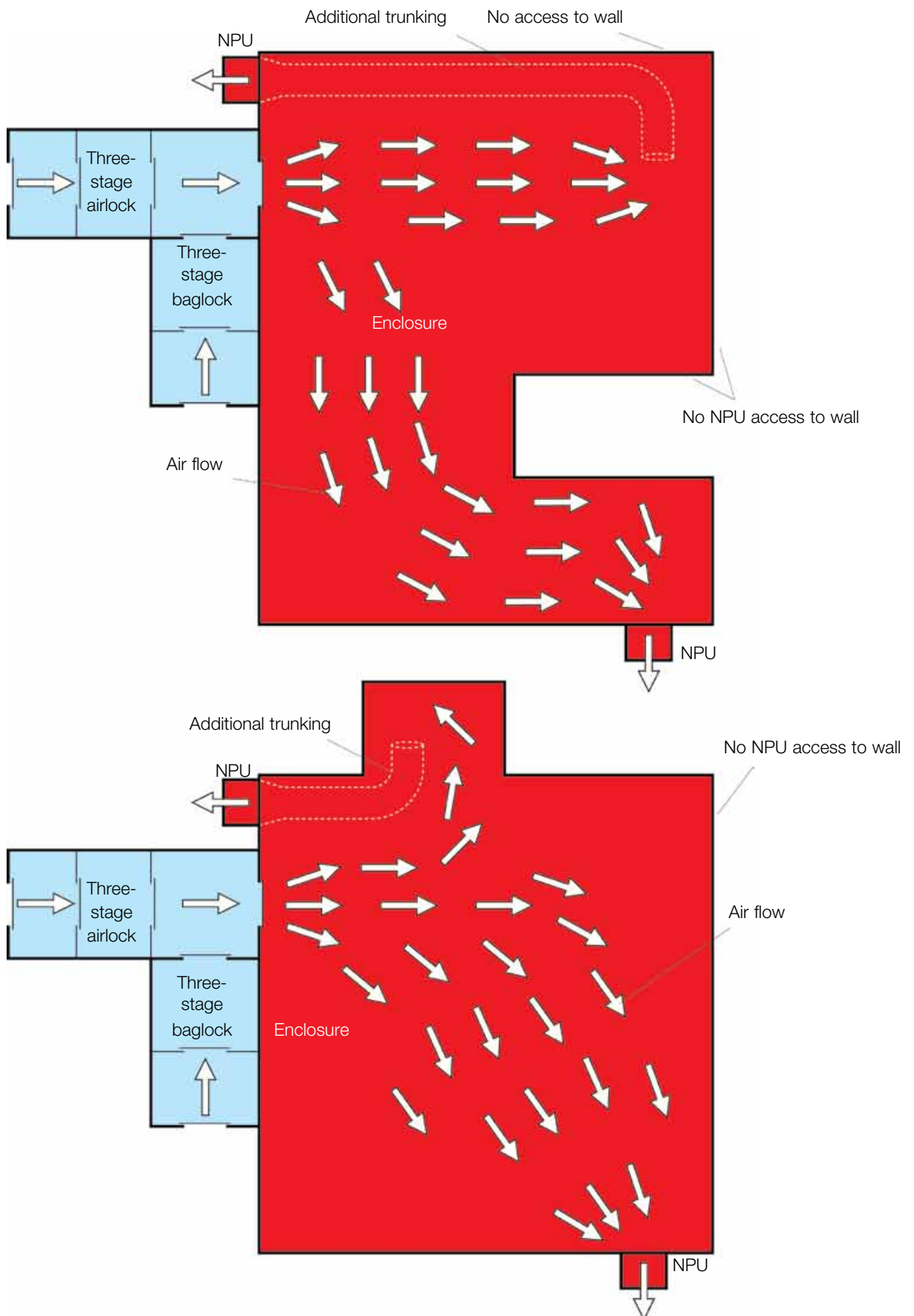
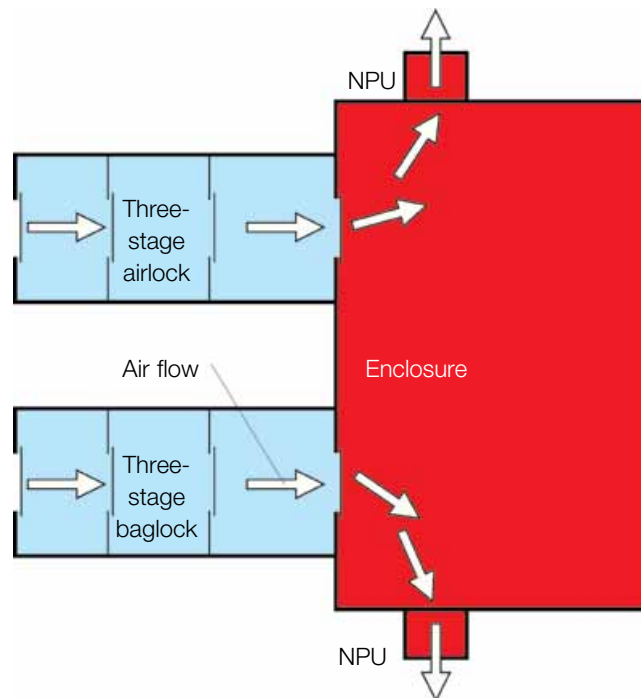

Figure 6.15 Example of poor airflow management



6.44 Extract ventilation should be provided by a purpose-built unit incorporating a fan and suitable filters. The main characteristics of a good extract ventilation system (see Figure 6.16) are:

- **Adequate filtration.** The system needs to incorporate a high-efficiency (HEPA) filter of at least 99.997% efficiency when tested in accordance with BS 3928: 1969 or the Dioctyl phthalate (DOP) test. The filter needs to be installed on the negative pressure side of the fan and well sealed around its edges to prevent leakage of contaminated air. The HEPA filter will be the final stage of filtration. Their high efficiency capability means that large quantities of dust should be avoided. Therefore to prolong its working life, other filter(s) should be incorporated into the system. A coarse pre-filter should be fitted before the HEPA filter and it may also be worthwhile fitting a second high efficiency filter. The machine is then tested as a whole to show that as a unit it has at least 99.997% efficiency.
- **Adequate fan performance.** The fan is required to run for extended periods of time. It also needs to be capable of achieving its rated airflow against the resistance flow presented by the filters (which will become increasingly dirty and partially blocked), and any discharge ducting installed and possibly from wind pressures if discharging outside. The use of ducting can cause considerable losses in airflow, typically 0.05-0.07 m³/s (100-150 CFM) per 6-metre length. Ducting length must therefore be taken into account in calculating the required ventilation rate. Manufacturers can advise on specific airflow losses linked to ducting type and dimensions (length and diameter). In practice this usually means that a centrifugal fan should be used. Fan sizes usually range from 0.084-2.36 m³/s (200-5000 CFM).
- **Robust construction.** The system needs to be designed for continuous operation and should be constructed of materials of sufficient strength to withstand the wear and tear of normal usage, including frequent transportation and a degree of rough handling.
- **Reverse flow damper.** A damper or other device needs to be incorporated in the extract system to prevent reverse flow as a result of fan failure or adverse wind conditions. Reverse flow would put the enclosure under positive pressure with respect to atmosphere, resulting in the outward leakage of unfiltered air.

- **Indication of flow.** A manometer or similar device should be fitted to NPUs to indicate that the system is providing an adequate airflow. An audible or visual warning of low airflow (eg due to filter blockage) is also recommended. Low airflow is when the airflow drops below the normal or specified output of the unit (which is linked to the minimum air change rate specified for the enclosure, eg 8 air changes per hour (see paragraph 6.47)). The manometer reading should be checked as part of a visual inspection at the start of each shift (see Box 6.1).
- **Discharge ducting.** The contaminated air from the extract systems should be discharged to a safe location in the outside atmosphere. Ducting should discharge in a safe place away from air intakes, windows, occupied areas, etc, and preferably away from the sides of buildings or other obstructions where back pressure could occur in high winds. The dimensions (length and diameter) of the ducting used will be dependent on the location and type of extractor used, especially the diameter of the exhaust outlet pipe.

Figure 6.16 Extraction ventilation unit, showing typical construction features

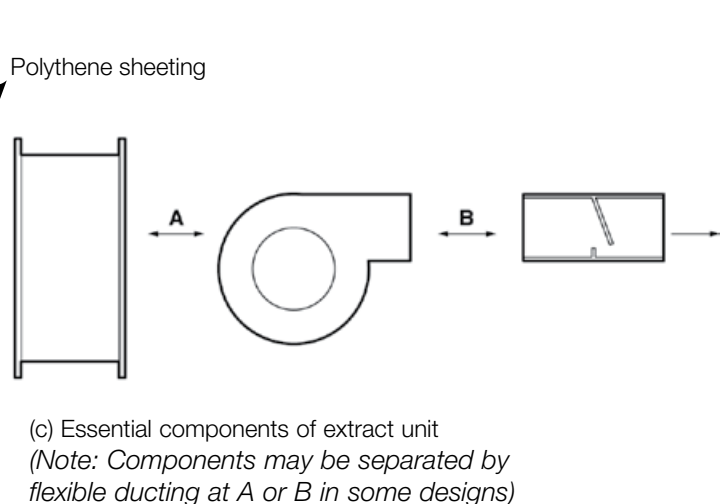
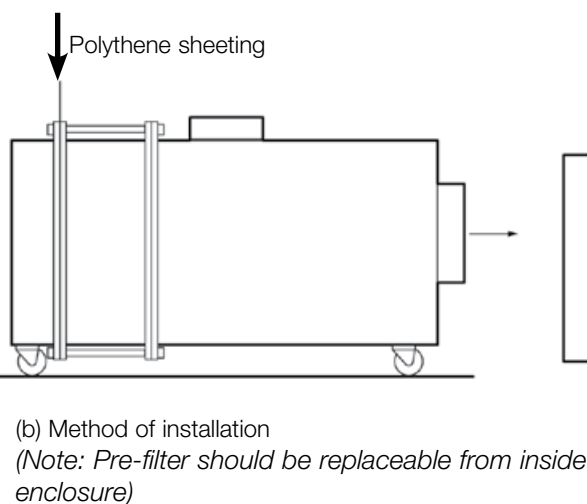
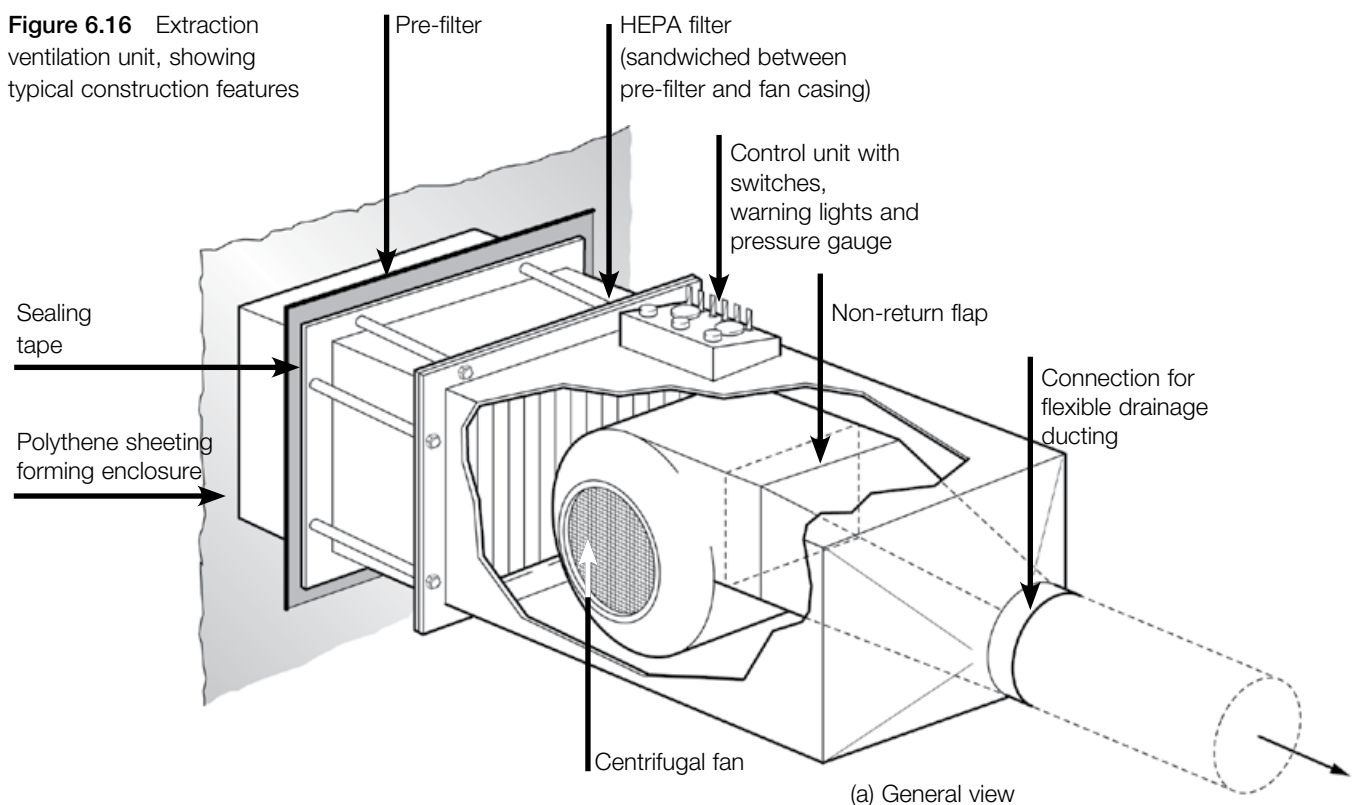

6.45 It is often necessary to replace pre-filters during the course of a job. It is recommended that stripping operations stop while this is done, to prevent overloading the HEPA filter. The pre-filters need to be accessible from inside the enclosure without disturbing the HEPA filter, and when the pre-filter is to be removed or replaced, the fan needs to be turned off (work should also stop). Replacement of the final high efficiency filter is more complex and will require special precautions. The normal practice would be to remove the NPU from the enclosure and install a replacement. Filter replacement would subsequently be carried out by a specialist contractor under controlled (ie ventilated) conditions in their premises. There should be strict procedures for the work and it should be undertaken by competent trained personnel wearing adequate PPE. After replacement of the HEPA filter, the NPU should be DOP tested to ensure the equipment performance is satisfactory, ie that the filter is correctly installed and sealed.

6.46 The level of negative pressure within the enclosure is dependent on several factors, particularly the extract flow rate and the extent of leakage from the unit. Calculation of the ventilation rate must take account of the volume of the enclosure and the volume of the airlock and baglock. It must also include additional allowances for reduced airflow due to the filters and ducting and due to external influences (wind pressures). The ventilation rate selected will only be a guide to the negative pressure within the enclosure as the actual pressure will depend on the extent of leakage into the enclosure. The degree of negative pressure needs to be assessed using a combination of methods including monitoring (see paragraph 6.53), visual observation of flow conditions and the use of indicators such as smoke tubes.

6.47 The exact ventilation requirements for each enclosure will have to be determined on an individual job basis (based on enclosure size/volumes, building layout etc). However, while extract system flow rates cannot be specified in detail, experience has shown that in many cases a flow rate of about 0.2 m³/s for each 100 m³ of enclosed volume (100 ft³/min per 1000 ft³) appear to give a satisfactory performance. This is equivalent to approximately 8 air changes per hour in the enclosure. Where there are difficulties in obtaining an effective seal, it may be necessary to overextract to compensate. Extraction rates should not be excessive, causing damage to the integrity of the enclosure (eg collapsing in on itself). The above rates may not be appropriate for large enclosures. In very large enclosures, such as power stations, the maintenance of internal negative pressure may be impracticable. In many cases more effective extraction can be achieved by subdividing work areas into smaller units (see paragraph 6.19).

Testing, monitoring and maintenance

6.48 The responsibility for monitoring and maintenance of the enclosure can be allocated to a nominated, trained and competent person, and there needs to be a system devised which sets out the procedure and frequency of inspection. The results of the visual inspection, monitoring and maintenance need to be recorded in a log book. The named person should also be responsible for those duties. It is recommended that management inspect the log book at frequent intervals. There are several tests and checks which should be carried out.

Visual inspection

6.49 Before asbestos work starts, a thorough visual inspection of the enclosure is required to ensure that it has been constructed correctly and that it is effectively sealed. Particular attention needs to be paid to seals, airlocks, joints, and the fitting of sheeting around pipes, pipe trays, conduits, etc.

Figure 6.17 An enclosure being smoke tested



Smoke testing

6.50 The enclosure should be tested by releasing smoke from a smoke generator inside the enclosure with the air extraction equipment switched off (see Figure 6.17). Escaping smoke indicates leaks which need to be dealt with, as far as possible.

6.51 Once the enclosure is full of smoke, all external areas should be checked for the presence of smoke. This should include the floors above and below as appropriate and any foreseeable locations that smoke could emerge, including less obvious locations, eg by passing through cavity walls. Major leaks may be apparent but not always. In certain circumstances, smoke may take some time to emerge, eg in complex buildings, or where enclosure walls have intricate or multiple folding and pleating. The visual check should be conducted over a sufficient time period. Minor leaks will not always be obvious. These minor leaks can still result in the significant contamination of adjacent areas. The easiest way to check for smoke released from minor leaks is to shine a torch beam along the area being checked (see Figure 6.18). Minor releases of smoke will be shown up across the beam of light. Where the source of the minor leak cannot be traced, reliance may have to be placed on the enclosure's air movement (see paragraph 6.47).

6.52 Once the smoke has been cleared and any leaks eliminated, the enclosure needs to be tested with the air extraction equipment running. The airlock flaps will be lifted by the airflow through the system and the enclosure walls will bow inwards indicating slight negative pressure inside the enclosure, ensuring that any residual leaks are inwards. In any event, air will need to flow through the enclosure purging the airlocks, establishing circulation within the enclosure and allowing correct functioning of the air extraction equipment. Additional leak testing can be performed externally using smoke tubes, while the air extraction equipment is running, and noting any smoke sucked inside. Smoke tube testing should be carried out around particular seals and joins to ensure they are effective. Such small amounts of smoke will not adversely affect the HEPA filter. Only when the integrity of the enclosure and extraction equipment is proven, can asbestos removal work begin.

Differential pressure monitors

6.53 The relative pressure in the enclosure can be monitored using differential pressure monitors. These instruments provide a continuous indication of the 'negative pressure' (relative to atmospheric pressure) within the enclosure. A pressure difference of about 5 pascals or above (0.5 mm water gauge) is usually sufficient to ensure that there is not net outward movement of air from an enclosure within a building. However air pressure within the enclosure may not be uniform and can be subject to external influences. In particular outside wind pressure (ie strong winds) can affect the air pressure within the enclosure through direct impact on the enclosure side (including floor and ceiling) or through draughts from open doors and windows in the building. So, considerable care is needed when using differential pressure monitors, as misleading results can be obtained. Users should be properly trained. Monitoring results should always be used in conjunction with other indicators of the correct functioning of NPU's, ie satisfactory smoke tests, tautness of enclosure walls and position of airlock flaps.

6.54 A thorough visual inspection of the enclosure should be carried out at the start of each working shift to check for any breaches and to establish that the internal negative pressure is maintained (ie the sides of the enclosure are drawn in). The NPU pressure gauge should be checked to ensure there is sufficient airflow. It is also recommended that tests with smoke tubes or differential pressure monitors be carried out at frequent intervals. Daily checks should be performed where the enclosure is located in an occupied building. The results of the visual inspection, monitoring and maintenance need to be recorded in a log book.

Figure 6.18 A torch being used to find smoke leaks



Viewing panels

6.55 Viewing panels should be checked frequently and cleaned as necessary to ensure clear views of the inside of the enclosure. Panels can be wiped down as required. Airborne dust will readily adhere to the perspex surface and will provide an indicator of the extent of dust generation within the enclosure. If they need to be cleaned regularly, this suggests limited effectiveness of the controlled stripping techniques.

Air monitoring

6.56 Air monitoring should be carried out periodically to confirm that the enclosure, airlocks and air extraction equipment are working effectively and no asbestos has spread outside. Monitoring should be performed once work starts and then periodically to demonstrate continued effectiveness of the system. Air monitoring in the vicinity of the NPU discharge outlet(s) is necessary where it vents inside the building. This is particularly important if it has been necessary to replace the NPU during the operation. Daily monitoring should be performed where the enclosure is located in an occupied building. However monitoring should never be seen as a substitute for frequent thorough visual inspection of the enclosure. The requirement for monitoring and its extent will depend on the nature of the work and location. More attention needs to be given to occupied or sensitive areas and less to unoccupied or remote locations. Full details on airborne sampling for asbestos is given in *Asbestos: The analysts' guide for sampling, analysis and clearance procedures*.⁸

Testing and maintaining air extraction equipment

6.57 Current procedures for the operation and maintenance of air extraction plant need to be clearly set out, and the users given adequate instruction on how to operate the system correctly. The system needs to be correctly installed and checked by a competent person before use; in particular, it is important that the equipment is checked to ensure that it is in good condition and has been properly assembled. A maintenance schedule needs to be formulated and carefully followed, and clear instructions given on the action to take if the unit breaks down or fails to achieve specified performance, eg work should stop and the equipment be replaced.

6.58 Thorough examination and testing of air extraction equipment must be carried out at least every six months by a trained and competent person. This normally involves thorough decontamination and dismantling of the equipment, a visual examination of component parts to establish that they are in efficient working order and in good repair, and the changing of all filters (unless there is no significant loss of airflow). The performance of the unit should be checked after it has been reassembled to establish that airflow through the unit and pressure drop across the HEPA filter meet the manufacturer's specification. Where the airflow has dropped below its design capacity (eg a 2000 CFM unit is only achieving 1500 CFM), this should be clearly marked on the unit itself and the lower figure used in ventilation calculations. Air monitoring in the vicinity of the exhausted air may also prove useful in establishing that the equipment is functioning correctly in practice following the thorough examination. However, if it passes the required 99.997% efficiency, this may not be necessary. A record of inspection, thorough examination, routine maintenance and any defects remedied must be kept available for inspection.

6.59 The extraction system needs to be turned on before work starts, and be left running continuously throughout the stripping work, including times when personnel are not on site. If it is not reasonably practicable to leave the system running continuously outside normal work days, it can be left on during breaks and for a sufficient period at the end of each shift to clear the enclosure of airborne dust (at least one hour). On such occasions, access points to the enclosure should be closed and sealed. Automatic time-delay switches may be used for this purpose.

The extraction unit needs to be turned on and off from outside the enclosure, and the switches should be clearly identified. When personnel are not on site, reasonable steps need to be taken to prevent the enclosure being tampered with.

Box 6.1 Enclosure checks

- Visual inspection and smoke test before work starts.
- Visual inspection before each shift, including checking the NPU pressure gauge.
- Additional checks with smoke tubes and pressure testing inside the enclosure (daily if the building is occupied).
- Air sampling:
 - Occupied buildings:* daily:
 - in the vicinity of the enclosure;
 - ‘weak spots’ (eg sealed joints);
 - airlocks and NPU discharge point(s).
 - Other situations:* soon after work starts and then periodically:
 - locations as above.

Dismantling and disposal

6.60 When asbestos removal work has been completed, the enclosure or work area must be cleaned, inspected and tested in accordance with the requirements of the four-stage clearance procedures (CAWR, regulation 16). The clearance procedures will be different where there is no enclosure (see paragraph 6.57). Guidance on site clearance preparation and four-stage clearance procedures is given in paragraphs 7.102-7.146.

6.61 If the clearance air test result is satisfactory, the enclosure should be carefully dismantled. Following dismantling, stage 4 of the four-stage clearance procedure can be conducted, ie the site of the work area should be visually inspected to ensure that no asbestos waste or debris was hidden by the enclosure or released during its dismantling. If any contamination is found during the dismantling operations, further cleaning must be carried out and the process of visual inspection and air sampling repeated.

6.62 There is still potential for exposure to asbestos fibres during dismantling of the enclosure. Fibres can be released from the surface of polythene sheets or from trapped locations in or under sheeting (eg folds and pleats) or hardboard. Therefore suitable PPE should be worn and safe systems of work employed. The PPE should consist of normal coveralls and half-masks (eg disposable FFP3 respirators). All polythene sheeting should be sprayed with PVA sealant before removal. This will minimise the release of fibres adhering to the surface through static electricity. The sheeting should be carefully removed from the framework, rolled or folded neatly and placed in waste bags. Polythene sheeting should not be reused due to its potential contamination and loss of integrity due to punctuating by staples. The sheeting should be disposed of as asbestos waste.

6.63 The NPU should be checked to ensure that it is firmly sealed. It can go directly to the next job or, if necessary, be taken to a suitable decontamination workshop for maintenance. Equipment must not be sent to firms, manufacturers, etc, for maintenance unless they have decontamination facilities or the equipment has first been thoroughly decontaminated.

6.64 There may be occasions after the work has been completed and the certificate of reoccupation has been issued that some additional airborne sampling will be desirable or appropriate. This 'reassurance sampling' is not part of the formal clearance procedure but would be undertaken in situations where it is possible that some residual asbestos may remain and testing is required to ensure that it presents no risk. These types of situations would include: where suspect asbestos has been trapped in inaccessible crevices and, although permanent sealing has been performed, checking is desirable to confirm that it has been effective; or where complex items of plant, electrical equipment, or porous brickwork had been sheeted over inside the enclosure, and checking is required to confirm that no asbestos penetrated the sheeting. With good planning and careful work practices these situations should be avoided. Reassurance sampling is unlikely to be routine and is not a substitute for any part of the clearance procedure.

6.65 Problems arising from cleaning access equipment used in the enclosure can often be minimised if sufficient planning has taken place before the equipment is taken into the enclosure. The ends of scaffold tubes should be capped and, where possible, the scaffold boards covered with polythene to ensure effective cleaning can be carried out. However boards used inside an enclosure for access to plant at high level may create a slipping hazard if covered with polythene. It may be overcome by using additional boarding, eg plywood. In such cases, the risk needs to be carefully considered before a decision is made.

6.66 Mobile equipment working platforms (MEWPs) (eg scissor lifts) can be used inside enclosures, provided that adequate arrangements are made to protect the equipment and for decontamination. Working parts (engine, hydraulic equipment etc) should be protected using properly designed robust sheeting (fabric material) which extends and contracts with adjustment of the platform height. Sheeting should extend as close as possible to floor or ground level and have provision to allow dispersion of exhaust gases (if appropriate) (see Figure 6.19). All exposed items (ie sheeting, lower parts of the equipment such as wheels and bodywork, and the working platform itself), should be decontaminated and cleaned before site clearance. MEWPs should be inspected as part of the four-stage clearance procedure. Sheeting should be treated with PVA before removal and then be disposed of as asbestos waste.

6.67 Where there is no enclosure, site clearance will follow most of the normal process, but there will be some important differences. There should be a preliminary check of site condition and job completeness, and a thorough visual inspection. The need for air monitoring will depend on the circumstances of the work. For example, if the work has been located outside then clearance air monitoring will not be expected. The final visual inspection will take place after all equipment and any other items, such as partial enclosures or protective sheeting, have been removed.

Emergency procedures

6.68 The risk of an accident occurring in an enclosure during asbestos removal is always a possibility, eg from working at heights in difficult or confined areas. Accordingly, emergency procedures for the evacuation of ill or injured personnel need to be built into the planning stage and detailed in the written assessment. This is now required under CAWR, regulation 14. Personnel need to be trained to deal with the emergency. It may be necessary to remove the victim's respirator at an early stage. Decontamination should be carried out as far as possible. Employees should vacuum themselves, and the victim, and sponge down RPE and boots. However evacuation of the seriously ill or injured employee should not be delayed by over-elaborate attempts to decontaminate the casualty. If the victim can be moved, work colleagues

can move them outside. If necessary, entry/exit may be made by slitting the walls of the enclosure. All personnel should decontaminate themselves in the hygiene facility again where possible. In some situations it may be necessary for the casualty to be treated inside the enclosure.

6.69 Arrangements for contacting the emergency services should be established. Information should be made available to the relevant accident and emergency services to enable those services to prepare their own response procedures and precautionary measures for asbestos and other hazards. Spare disposable protective clothing and disposable RPE should be kept available for personnel who have to enter the enclosure and who do not have their own equipment, eg ambulance personnel or paramedics.

6.70 As asbestos personnel work in many different premises and buildings, it is important that they are familiar with procedures and arrangements in the event of fire. Such matters should be covered as part of the site induction process. Workers should be informed of the nature of the fire alarms or systems and with the means of escape from the enclosure and the area in which it is situated. This will be particularly important if the enclosure (or indeed hygiene facility) is located in a relatively inaccessible part of the premises, or if the escape route is awkward or lengthy. If escape becomes necessary, evacuation from the premises should be the overwhelming priority. Escape should not be delayed by undergoing decontamination. In addition, RPE should be removed inside the enclosure if it inhibits or impedes escape. After reaching a safe area, PPE and RPE should be decontaminated as far as possible.

Chapter 7: Controlled techniques for the removal and repair of ACMs, including waste disposal



Summary

■ Wetting solutions

- Water on its own is not adequate to wet asbestos fibres.

■ Injection

- Needles should be sufficient to wet all areas of the ACM.
- Needles should be evenly spaced.
- Needles should penetrate the full depth of the ACM.
- Wetting should be through controlled capillary action and not forced delivery.
- ACMs, when 'wet', should be doughy in consistency.
- New equipment should comply with PAS 60.

■ Spraying

- Only wets the outer surface, although increased wetting can be achieved with several sprays over a number of hours.
- Is not suitable for thick pipe insulation or sprayed coatings.
- Can be used for many types of dust suppression (eg when dry spots are found, debris etc).

■ Dry stripping with control at source

- This technique includes wrap-and-cut, glovebags, shadow vacuuming, direct removal by vacuum systems and enhanced air management.
- Is used where wet stripping is not possible or to supplement wet stripping techniques to further enhance control.

■ Waste disposal

- Any asbestos waste should be packaged, labelled and transferred appropriately.

■ Final clearance

- Final clearance should be performed by a person who is:
 - competent to do so;
 - independent of the contractors carrying out the work.
- Final clearance should be carried out in four stages:
 - Stage 1: Preliminary check of site condition and job completeness;
 - Stage 2: A thorough visual inspection inside the enclosure/work area;
 - Stage 3: Clearance air monitoring;
 - Stage 4: Final assessment post-enclosure/work area dismantling.

Contents

Introduction 113

HSE research 114

Choosing an asbestos stripping technique 115

Does the ACM need to be removed? 115

Asbestos stripping techniques 116

Basic guidelines 116

Controlled wet stripping 118

Dry stripping with control at source 125

Asbestos stripping situations to avoid 130

Uncontrolled dry stripping 130

High-pressure water jetting 130

Power tools 130

Hot working 130

Site cleaning and preparation for four-stage clearance 133

Disposal of asbestos waste 134

What is asbestos waste? 134

How to package and label waste 135

Transfer of waste to sealed skip or vehicle 137

Storage of asbestos waste 138

Transfer for disposal 138

Carriage of dangerous goods requirements 138

Site assessment for reoccupation (Four-stage clearance procedure) 139

Stage 1: Preliminary check of site condition and job completeness 140

Stage 2: A thorough visual inspection inside the enclosure/work area 144

Stage 3: Clearance indicator air sampling for the certificate of reoccupation 148

Stage 4: Final assessment post-enclosure/work area dismantling 150

Appendix 7.1: Labelling requirements for plastic bags/sacks containing asbestos waste 152

Appendix 7.2: Asbestos waste flow charts 153

Appendix 7.3: Asbestos waste tremcard information 155

Introduction

7.1 This chapter covers the following topic areas:

- general guidance on controlled asbestos removal techniques;
- the four-stage clearance procedure;
- cleaning and disposal of asbestos waste.

Box 7.1 The publicly available specifications (PASs) for equipment used in work with ACMs

Equipment used for the controlled removal of ACMs includes controlled stripping equipment, type 'H' vacuum cleaners, NPUs, and DCUs. Whatever equipment is selected for use, it should be of a standard sufficient to ensure compliance with CAWR. Employers of licensed asbestos removal operatives should ensure that any equipment they hire or purchase is capable of performing to the standards required. For example wet stripping equipment can only be deemed to be controlled stripping equipment, if it is able to thoroughly wet all areas of the asbestos insulation. One way of ensuring that the equipment you hire or purchase is fit for purpose is to only use equipment that meets PAS 60. Full details on PAS 60 are given below:

PAS 60 'Equipment used in the controlled removal of asbestos containing materials' has three parts, each constituting an individual specification or code of practice:

Part 1 (PAS 60/1): 'Controlled wetting of asbestos containing materials - Specification'. This specification includes sections on design, instructions for installation and use, labelling and conformity marking with an annex on flow measurements from needles. It does not however include information on wetting fluids and wettability.

Part 2 (PAS 60/2): 'Negative pressure units - Specification'. This is similar to Part 1 in that it includes sections on design, instructions etc but has two annexes on airflow testing and reporting. It should help address the issue of defining airflow capacity.

Part 3 (PAS 60/3): 'Operation, cleaning and maintenance of type 'H' vacuum cleaners - Code of practice'. This document is different. It is a code of practice on training, operation, cleaning, maintenance and record-keeping for type 'H' vacuum cleaners. It contains a requirement to have a filtration test certificate for the entire vacuum cleaner and not just for the HEPA filter. It also has similar requirements for filtration testing to those in PAS 60/2.

Licensed contractors will be expected to ensure that any new equipment they buy conforms to the relevant PAS specification. Equipment that conforms to PAS 60/1 and 60/2 will be clearly labelled and should be easy to identify. As far as manufacturers are concerned, it will be in their interests to ensure that they are able to supply their clients with equipment, which conforms to the relevant PAS specification. Contractors will be able to comply with PAS 60/3 by putting in place and implementing a regime, which fulfils the requirements of the code of practice for type 'H' vacuum cleaners.

Figure 7.1 Uncontrolled dry stripping



7.2 This chapter revises and replaces the HSE guidance *Controlled asbestos stripping techniques*. It gives practical advice on techniques for the safe removal of ACMs, covered by the Asbestos (Licensing) Regulations 1983 (as amended),¹ ie asbestos insulation, asbestos coating and AIB. It does not cover the following:

- the safe removal of ACMs not covered by the Asbestos (Licensing) Regulations 1983 (as amended).¹ However, guidance on non-licensed work is given in *Asbestos essentials*. There are two publications, *An introduction to asbestos essentials*¹³ and *Asbestos essentials task manual*,² both available from HSE Books. Detailed guidance on working with asbestos cement is given in the HSE guidance *Working with asbestos cement*;³
- work clearing land contaminated with asbestos. However, some of the principles discussed here can be applied to work on contaminated land;
- safe means of access, demolition, use of ladders and scaffolding etc. Guidance on safety on construction sites can be found in the HSE construction information sheets CIS49²⁸ and CIS10,²⁹ and in the HSE guidance *Health and safety in roof work*.³⁰

HSE research

7.3 The guidance given in this document takes account of the findings of HSE-sponsored research on:

- exposures experienced during dry stripping of asbestos;
- exposures experienced during controlled wet stripping of asbestos;
- the workplace effectiveness of RPE.

7.4 Several conclusions have emerged from this research, including:

- **uncontrolled** dry stripping of asbestos must not take place as it exposes asbestos stripping workers to very high concentrations of asbestos fibres, levels well in excess of the protection provided by RPE (see Figure 7.1). **Note that ‘uncontrolled dry stripping’ means the removal of asbestos while in a dry state and using direct action on the asbestos (ie power tools, axes, hammers etc). It does not include the use of acceptable controlled techniques, eg unscrewing tiles or boards with shadow vacuuming;**
- controlled wet stripping techniques can minimise the release of asbestos fibres and help to contain the spread of contamination;
- improved rates of wetting are achieved by the use of wetting agents;
- a combination of controlled stripping techniques is often needed for effective control;
- controlled stripping techniques require disciplined work practices;
- RPE should **not** be relied upon as the sole way of controlling exposure during asbestos stripping;
- the effective workplace protection provided by RPE has been found to be much lower than when it is measured in laboratory tests;
- the stripping of asbestos from live heating systems and other hot environments leads to increased fibre levels and reduced performance of RPE, and the potential for heat stress. It can only be carried out in exceptional, fully justifiable circumstances, after completion of an adequate RA.

7.5 These findings emphasise the importance of regulation 10 of CAWR. This regulation requires employers to **prevent** exposure of their employees to asbestos, or where this is not reasonably practicable to **reduce it to the lowest level reasonably practicable by measures other than using RPE**.

Uncontrolled removal of asbestos can result in exposures of 1000 f/ml

Controlled removal of asbestos can result in exposures less than 1 f/ml, and even less than 0.01 f/ml

Choosing an asbestos stripping technique

Does the ACM need to be removed?

7.6 Before making any decisions about how the ACM should be removed and the control techniques to adopt, first consider whether the ACM needs to be removed (this has been discussed in more detail in paragraphs 1.42–1.45).

7.7 Where the decision is made to remove ACM, the licensed asbestos removal contractor needs to consider a number of matters before deciding on the stripping technique, or combination of techniques, to use (these should be detailed in the assessment and POW). These matters include:

- the need to minimise the amount of fibres generated at the point where asbestos is being stripped. Power tools should be avoided where possible and the asbestos should not be dry when worked on, with the exception of, eg electric screwdrivers used to unscrew AIB panels;
- the type of ACM, eg:
 - where there is an impervious cement layer on pipe lagging which will resist wetting;
 - where lagging such as blankets is better wetted using sprays rather than injection;
 - where AIB is fixed by different methods (eg screws, nails, clips or glue);
- the surface onto which the asbestos has been applied. For example a sprayed coating may have been applied onto a bituminous layer on structural steel work. This will make the removal of residual asbestos difficult;
- the location of the ACM and the nature of the work area;
- the need to prevent the escape of asbestos fibres from the enclosure to the general environment. The use of controlled stripping techniques will minimise the concentration of asbestos fibres within the enclosure and make their containment easier. Further guidance on the design and construction of enclosures is given in Chapter 6.

7.8 In addition to the requirement to reduce exposure to asbestos as low as reasonably practicable, the licensed contractor also needs to consider the conditions under which the work will be carried out. Such conditions include where:

- the presence of live electrical equipment will prevent, or restrict, the use of controlled wet stripping;
- the presence of chemicals may present a direct risk to the workers or prevent the use of controlled wet stripping techniques;
- the use of wetting agents may create a risk of slips. This is particularly important when working at height.

7.9 ACMs should not be removed or repaired in hot environments. This applies to work on, or adjacent to, hot plant and to circumstances or conditions where the enclosure is likely to reach very high temperatures for other reasons. Enclosures will get hotter as insulation from live pipework is removed. If, in extreme circumstances, the asbestos has to be removed or repaired while the plant, or adjacent plant is on, an assessment of the associated risks should be carried out and the methods to reduce the risk of heat stress established (see paragraphs 7.72–7.80).

Do not work on ACMs on or adjacent to hot plant

7.10 These factors should be considered in co-operation with the client to ensure that the work is carried out as safely as possible. Liaison with the client or the client's agents is necessary to ensure that all the factors, which might influence the safety of the work, have been taken into account in the assessment and POW.

Asbestos stripping techniques

Figure 7.2 Wrap-and-cut



Basic guidelines

7.11 The primary objective in asbestos removal work is to prevent or minimise fibre release, ie remove the asbestos in a safe manner. This should always be the main priority. So the choice of stripping method and the work methods need to be carefully considered to make sure that the most appropriate techniques are employed. The chosen stripping method (or combination of methods) should disturb the ACM as little as possible and the ACM should be treated or controlled to prevent fibre release.

7.12 There are a number of controlled stripping techniques which can be used to minimise the release of fibres during asbestos removal. These can be divided into the following two broad categories:

- controlled wet stripping (paragraphs 7.17-7.41);
- dry stripping with control at source (paragraphs 7.42-7.62).

The stripping method should disturb the fibres as little as possible

7.13 The type of method (or combination of methods) used in asbestos stripping will depend on a number of factors. These factors include:

- the type of asbestos product, eg lagging, sprayed coating, board;
- the thickness of the ACM;
- the presence and nature of any coating on the ACM;
- the type and nature of any fixing, eg nailed, screwed;
- miscellaneous factors, eg whether pipework is redundant, the material is damaged, accessibility, etc.

Figure 7.3 Injection



Figure 7.4 A low pressure spray



7.14 Paragraphs 7.14-7.16 provide a guide to the types of stripping methods that can be used for ACMs (the methods are discussed more fully in paragraphs 7.17-7.67):

Basic guidelines: Lagging and sprayed coatings (usually found on boilers, pipework, structural beams and columns)

- Is the pipework or vessel redundant? If yes, then wrap-and-cut may be appropriate (see Figure 7.2).
- Is the material relatively thick (greater than 1 cm) and covered with a coating which can be punctured by injection needles, eg encapsulated sprayed coatings? If yes, then low pressure injection can be used (see Figure 7.3).
- Is the material damaged? If yes, then wrap in polythene and tape up to prevent loss of fluid. Inject through the polythene.
- Is the material unsealed and relatively thin, for example unpainted sprayed coatings less than 1 cm thick? If yes, then controlled low pressure sprays can be used (see Figure 7.4).

Figure 7.5 Shadow vacuuming during unscrewing of board



Figure 7.6 Drilling using a low-speed drill with cowl and fitted with LEV



Figure 7.7 Textured coating being drilled through paste



- Is there an impermeable layer which cannot be punctured by injection needles, eg pipe lagging with a hard cement coating? If yes, then injection holes can be prepared by using:
 - hand drills and shadow vacuuming (this is where the nozzle, fitted with a suitable attachment, of a type H (BS 5415)³¹ vacuum cleaner is held as close as possible to the source of fibre release throughout the task (see Figure 7.5));
 - drilling using a low-speed drill with a cowl around the bit and fitted with LEV (see Figure 7.6); or
 - drilling through a viscous medium such as wallpaper paste or shaving foam (see Figure 7.7).

Basic guidelines: Boards and tiles

- Is one surface unpainted and accessible? If yes, then vacuuming and the use of controlled low pressure sprays on the unpainted surfaces, followed by shadow vacuuming during unscrewing, are appropriate. **Repeated wetting over approximately 24 hours can wet the board to a soggy cardboard consistency and reduce the need for shadow vacuuming.**
- Is the unpainted surface inaccessible? If yes, then shadow vacuuming while unscrewing is appropriate, with vacuuming of the exposed and unpainted surfaces followed by the use of controlled low-pressure sprays.
- Are both surfaces painted? If yes, then shadow vacuuming while unscrewing is appropriate.
- If the boards are nailed, take great care to minimise breakage during removal. Spraying of unpainted surfaces should be used as described above. To remove the board, the area of the nail should be strengthened with the use of heavy-duty tape and the board carefully eased away from the wall using a crow bar (or similar). Once the nail has been exposed between the board and timber, this can, where possible, be cut. Alternatively, if the boards can't be easily lifted without breaking, then scribing and breaking can be used. This should only be used if other, safer methods will not work as there can be significant fibre release. Wetting and shadow vacuuming should also be used to minimise fibre release.
- Magnets can be used to locate screws or nails which have been obscured due to painting or other coating. If the nails or screws cannot be easily found or if boards are glued, methods based on the above should be applied. There will be many and varied situations, however, the principles should be to avoid breakage as far as reasonably practicable, keep exposed surfaces wet and use shadow vacuuming when working on the AIB. This may involve paint strippers, breaking boards etc, but the RA should show that the most appropriate method has been chosen that reduces exposure as far as is reasonably practicable.
- Wetting of the AIB surface, particularly the upper surfaces of ceiling tiles, can be achieved using long (up to 2 metres) metal tubes with holes along their length. The metal tubes can be laid on the surface of the AIB and the wetting agent fed through in a controlled manner.

Basic guidelines: Additional good practice

7.15 In addition to the use of controlled stripping techniques, there are other elements of good working practice which are needed to control exposure.

- The selection and use of tools and equipment can greatly affect exposure levels; abrasive power and pneumatic tools in particular can create high fibre concentrations. Every effort should be made to avoid the use of such tools, ie **power tools should be avoided**. Manual tools should be used with shadow vacuuming where possible. However, where the use of abrasive power and pneumatic tools is unavoidable, they should be used at the lowest effective speed with additional control measures such as LEV. Examples include a cowl

fitted with extraction located around a drill bit (the cowl should be fitted with a spring so that it remains in contact with the surface of the material as the drill bit penetrates) or shadow vacuuming.

- It is essential that every worker receives adequate training (where identified as a training need, including refresher training), in the use of controlled stripping techniques, and that there is adequate site supervision. More detailed training will be required for site supervisors. Good control techniques can be made worthless by poor work practices, resulting from a lack of training and supervision. Chapter 4 on training provides guidance for training operatives and supervisors for work with asbestos insulation and coatings.
- The use of controlled stripping techniques does not remove the need for close supervision and checking that the standards of control and work methods are being maintained. Viewing panels provided in enclosures allow supervisors to check that operators are following instructions and taking the necessary precautions. If PVC is used for viewing panels, it will attract airborne fibres and therefore its visible dustiness will be an indication of the effectiveness of the wetting.
- Maintenance of control equipment is essential to ensure it continues to operate effectively.
- Good waste control measures need to be used, including clearing away waste material as work progresses.

7.16 While some controlled stripping methods (eg multi-point injection) can, in principle, achieve more control than others, the whole range of controlled techniques may need to be considered for a particular job. A combination or series of approaches may be needed for effective control in different aspects or phases of the work, eg the use of hand or low-powered sprays to dampen asbestos during the removal of metal cladding from lagging.

Controlled wet stripping

Wetting agents

7.17 Asbestos fibres can be effectively suppressed if the material is properly and uniformly soaked or wetted with a liquid. Some materials can be wetted naturally with water (eg chrysotile). These are described as hydrophilic. Other materials such as crocidolite and amosite are hydrophobic and tend to repel water due to a high surface tension. However, the wetting property of water can be improved through the use of surface acting chemicals (or surfactants, but commonly called wetting agents or detergents). Wetting agents increase the affinity of water to solid materials enabling them to be more readily wetted. Crocidolite and amosite can be effectively wetted with water containing a wetting agent. In addition, wetting agents should also be used with chrysotile products as amphibole asbestos and other hydrophobic materials may be present (eg calcium silicate), and the wetting agent will speed up and improve the efficiency of the wetting process.

Water on its own will not adequately wet asbestos fibres

7.18 Wetting agents can be applied by injection or spraying, and are supplied either ready for use or requiring further dilution. Dilution can be typically between 10:1 and 15:1, according to the manufacturer's recommendations. Some wetting agents can ease removal by loosening the binding agents within the ACM.

Principles for controlled wetting

7.19 To achieve effective controlled wetting, several basic rules and principles need to be understood.

Figure 7.8 Good practice:
Wet injection on a large pipe



Figure 7.9 Good practice:
Wet injection on pipework



- The objective is to wet the material all the way through. Dry or partially wet patches will lead to high fibre levels.
- The wetting agent should be applied at a rate at which it can be absorbed by the asbestos. Excessive supply rates will lead to loss of wetting agent and incomplete wetting.
- Wetting is not an instantaneous process. Sufficient time should be allowed for the wetting agent to thoroughly penetrate the ACM. The time taken will depend on the type of ACM being injected. More porous and less dense materials, such as sprayed asbestos coatings, become saturated much more quickly than denser and less porous materials such as hand applied and high calcium silicate pipe lagging. It is therefore important that the workers carrying out the wetting and their supervisors have sufficient training and experience to judge when it is safe to begin removal. Some materials may be removed after only 3-4 hours soaking, while others may require up to 24 hours.
- Avoid over-wetting to prevent the wetting agent seeping out of cracks in the asbestos and presenting a slip hazard. It can also cause a slurry which can be difficult to deal with. Wrapping any damaged pipe lagging (eg with cling film) can collect any wetting agent (and asbestos debris), which may seep out. Alternatively drip trays or troughs can be placed under the pipework, although these can be difficult to position to collect the leaks.
- The degree of penetration and wetting should be checked by visual examination before attempting removal. With some ACMs, there is a visible colour change when adequate wetting has been achieved. Lagging should be of a dough-like consistency when adequately wetted. The use of dyes in the wetting agent may also assist examination.
- Small samples taken to determine the degree of penetration and wetting should be from areas remote from the pump or towards the last group of needles. During such testing, 'shadow' vacuuming should be used and if any exposed dry patches are found, they should be sprayed immediately and then re-injected.
- Good wetting:
 - Complete wetting of the asbestos coating or lagging.
 - The asbestos is wet to a doughy consistency.
 - Exposure levels are controlled to less than 1 f/ml.
- Poor wetting (causes: pressure too high, wrong needles, or needles poorly positioned):
 - Areas of the asbestos coating or lagging are completely dry.
 - Areas of the asbestos coating or lagging are sodden, with the asbestos falling off under its own weight.
 - Exposure levels are 100 f/ml and higher.

Controlled wetting using injection

7.20 Injection techniques can be used when the outer surface of the ACM is sealed, covered or coated and the skin will prevent loss of fluid (eg see Figures 7.8 and 7.9). Injection systems come in two basic forms: multi-point and single point. Multi-point systems have a number of needles connected together and are connected to a common injection pump. 'Hedgehogs' (where the needles are grouped together on a flat board) are appropriate for flat surfaces, such as sprayed coatings on ceilings or beams or lagging on flat plant (see Figure 7.10). Alternatively a 'string of needles', usually set 10-15 cm apart and linked by tubing from the injection pump can be wrapped around the item containing asbestos (see Figure 7.11). The needles in this system can be fitted with individual flow control valves which allows adjustment to ensure the appropriate volume of fluid is delivered to each needle. The string-of-needle system is extremely flexible and has a much greater range of application than hedgehogs. The latter system is also less practical and requires repeated placing of the unit on the ACM, increasing the potential for dry spots and wetting time. Single-point injection systems such as needle guns have very limited application. Their main use is inaccessible areas, where it is difficult to set up a multi-

point unit. Single-point injection systems should never be used in place of multi-point systems.

7.21 Injection needles are available in many sizes and designs. The specification of the needle will depend on the characteristics of the ACM, particularly thickness, shape and condition.

- Thin coatings or insulation (1 cm or less) require needles with holes at the tip, or long, angled needles. This allows the needle to be pushed into and flat with the thin coating (see Figure 7.10). These angled needles help the lateral movement of the wetting agent.
- Thick coatings or insulation require long needles with holes along their length, sufficient to penetrate the full depth of the insulation. The holes should face the substrate.

Figure 7.10 Needle board (hedgehog) multi-point injection system and angled needles for use on thin layers of asbestos, eg a sprayed coating

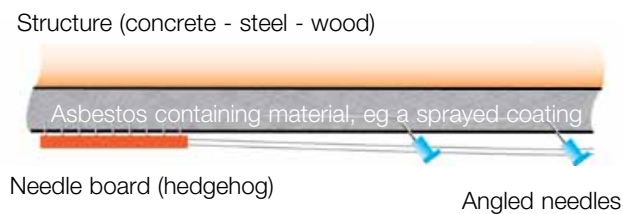
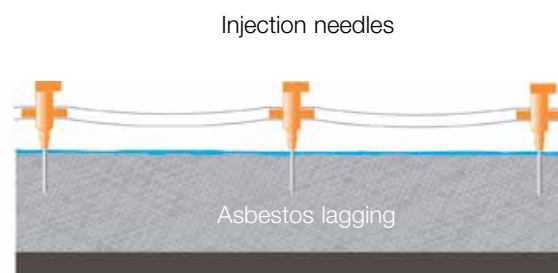

Figure 7.11 Controlled multi-point injection delivery through a network of fine needles



7.22 Once the needles have been selected, consider carefully where to place them. There are a few simple guidelines to follow:

- injection should be carried out in a methodical manner. If the needles are placed too far apart, dry patches will occur;
- the greater the number of needles, the more likely it is that uniform penetration will be achieved;
- where reasonably practicable, the wetting agent should be applied from the top so gravity helps it move through the asbestos;
- horizontal pipes should have needles running along the top of the pipe, spaced 10-15 cm apart (see Figures 7.8 and 7.9), allowing the wetting solution to diffuse down from the top of the lagging;
- large diameter pipes may need additional runs of needles, again towards the top of the horizontal pipe;
- vertical pipes should have needles placed horizontally around the top of the pipe, allowing wetting solution to diffuse as a wet band down the lagging. They

- should not spiral down the pipe, but be in horizontal planes;
- tall vertical pipes may need additional horizontal rings of needles every 1-2 metres.

Figure 7.12 Wetting solution diffusing/flooding from needles

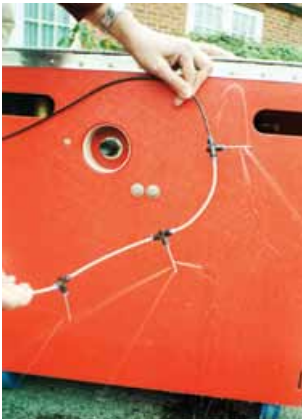

7.23 Wet injection techniques must be operated at low pressure to ensure that there is controlled and uniform wetting of the ACM. Wetting takes place through capillary action, but gravity will assist downward penetration. The wetting agent should be delivered at less than 3.4 bar (50 psi) pressure (needles with independent flow valves will allow much better control of fluid delivery). If higher pressure is used, it will force the wetting agent along the paths of least resistance (eg through cracks and fractures), leading to intermittent wetting.

7.24 Where lagging is covered by a cement-like layer (typically 6 mm thick), it may prove impossible to carry out injection without some preparatory work. Holes can be carefully drilled in the cement layer to allow access of the needles. Drilling can be a dusty procedure, so hand drills or a low speed drill should be used. The use of integral LEV can achieve additional control, eg cowls, by shadow vacuuming or by drilling through a viscous medium, such as wallpaper paste or shaving foam.

7.25 Pipe and vessel lagging may be covered in metal cladding, which will need to be carefully removed to expose the lagging material before injection. It may be possible to carry this out with minimal disturbance to the underlying lagging. However, if the underlying lagging is likely to be damaged, airless sprays and shadow vacuuming can be used as an effective way of controlling fibre release, while the cladding is carefully removed. But, if the casing can be drilled, full wetting should be carried out first.

7.26 Where the asbestos is damaged, injection may result in the material being disturbed or breaking off. If the damage is relatively slight, this can be avoided by the liberal use of sprayed wetting agent. If there is the potential for the asbestos to fall off the pipework or vessel, it can be wrapped in an impervious material such as polythene sheeting or cling film, taped and then carefully injected.

7.27 Take care when there is a suspicion that the insulation is damaged with internal cracking, or there are materials of varying porosity (eg where repairs have been made). These can result in areas of insulation which are difficult to wet as the fluid takes the line of least resistance. Where cracks are obvious, careful positioning of needles can ensure the fluid reaches all areas. Where materials of variable porosity are evident, varying flow rates can help. However, such problems may not be obvious and care should be taken when assessing the wetness of all the insulation before removal. Where cracking is evident, the insulation should be wrapped to contain the fluid (tanking), eg where damage is below the injection height, wrapping will be needed to ensure full wetting.

Remember that poor wetting can be no better than uncontrolled dry stripping, and very high exposures will result

7.28 Unless the assessment of the work shows that injection can be carried out without disturbing the ACM (or debris associated with it), the enclosure should be completed and smoke tested before carrying out any preparatory work or injection. It is up to the licensed contractor to prove that the method will ensure control, and they must consider the potential for fibre release from problems such as over-wetted asbestos falling and drying out.

7.29 PPE including RPE should be used when injecting. See paragraphs 5.13 and 5.30.

7.30 Asbestos stripping workers should receive specific and detailed training in the use of controlled stripping techniques, and in the problems which may be encountered.

Figure 7.13 Spraying AIB



Box 7.2 Controlled wetting using injection: Key points

- Ensure needles are correct for the ACM being removed.
- Multi-point systems should be used.
- Needles should usually be 10-15 cm apart.
- Needles should be positioned so that wetting agent can flow by capillary action to all areas. Dry patches should be avoided.
- Low pressure injection (3.4 bar (50 psi)) should be used.
- Needles with integral flow control valves aid wetting.
- Don't over-wet, a doughy consistency is about right.
- Allow sufficient wetting time.
- The equipment will need proper maintenance, testing and checking.

Controlled wetting by spraying

7.31 This technique can be used for applications where injection is inappropriate, due to the physical nature of the material (eg too hard, unsealed, etc). Spraying will generally wet the outer surface and penetrate only very thin porous materials. However, penetration and wetting can be extended by increasing the number of sprayings and allowing sufficient 'soak-time'. Spraying can also be used to prepare surfaces before injection or removal. In summary, spray wetting can be used in the following applications:

- where the ACM is unsealed and porous, eg thin, sprayed coatings;
- where the ACM is thin (less than 1 cm thick);
- the preparation of ACMs for removal, eg before the injection of damaged pipe lagging;
- the removal of AIB;
- asbestos textiles, including blankets and rope seals;
- in conjunction with glovebags;
- the removal of asbestos debris;
- work on asbestos cement. This is dealt with in *Working with asbestos cement*.³

7.32 The nature of the work being carried out and the volume of asbestos involved will determine the method of application. For relatively small applications, such as the preparation for injection or removal of AIB tiles (see Figure 7.13), operators can use hand-pressurised and operated spraying equipment, similar to that used in gardening. For more extensive applications, such as an unsealed sprayed coating, a low-pressure spraying machine (less than 3.4 bar (50 psi)) (eg airless spray system) or multi-point tubes can apply the wetting agent (see Figures 7.14 and 7.15).

7.33 The objective is to achieve thorough wetting of the ACM without disturbing it or producing an excessive quantity of run-off.

7.34 The method of application will vary depending on the type of material. Examples include:

- *Application on unsealed sprayed coatings:* spraying should be carried out with care over a defined area, using a wide-angled and fine spray. The spray should be moved continuously back and forward across the surface, avoiding disturbance. The number of spraying passes required will depend on the material. **Take care during the initial wetting to avoid disturbance of fibres.**

Figure 7.14 Multi-point
spray system



- *Application on unpainted AIB boards and tiles:* if the boards or tiles are unpainted on both surfaces, or an unpainted surface is readily accessible, they should be first vacuumed clean to remove all deposits of dust and debris and then sprayed as described in the previous sub-paragraph. Once they are thoroughly wet, they can be carefully removed by unscrewing and shadow vacuuming. A magnet can be used to locate the screws or nails if hidden by paint. Where the unpainted surface is not accessible, as is often the case with ceiling tiles, a single tile should be unscrewed using shadow vacuuming, then the unpainted top surface vacuumed and sprayed. Once access is available to the upper surfaces of the surrounding boards or tiles, they can be vacuumed clean and sprayed before removal, as outlined previously.
- *Application during preparatory work for injection:* as previously outlined, spraying can be used where the asbestos is slightly damaged and injection may result in the material being disturbed. Fibre release can be minimised by the careful, but liberal use of sprayed wetting agent on the damaged areas during injection.
- *Application on insulating blankets, ropes, quilt, etc:* wetting agents sprayed over all accessible surfaces can be effective in minimising fibre release during removal (injection is not appropriate for this type of material).
- *Application on hard surfaces (for example, Keens cement and bulldog coatings):* these coatings may be too hard to inject, and impermeable to the spray application of wetting agents. One method of removal is by drilling under controlled conditions followed by injection (see paragraph 7.24). Alternatively, this type of material can be removed by careful cracking while applying a fine spray. Once cracks appear, the spray can be directed along them to aid wetting. The material should then be carefully removed without further breakage. Shadow vacuuming can also be used in some circumstances. Because this type of material will not readily soak up the wetting agent, there is likely to be some spillage of the agent. Polythene sheeting or a suitable container should be placed beneath the spraying point to collect any spillage.
- *Application during the use of glovebags:* glovebags can be used to remove sections of pipe lagging. Although the asbestos is contained within the glovebag, the use of sprayed wetting agent during stripping can achieve additional control. The lance of a garden-type spray can be inserted through a purpose-designed access point and any gaps sealed. It is important to avoid over-using a wetting agent as this may put an added strain on the glovebag. Glovebags are discussed in more detail in paragraphs 7.50-7.55.

7.35 The time required for adequate soaking depends on the type of ACM and the purpose behind the application of the wetting agent. For example if it is being used to suppress fibre release during preparation for injection, only a few minutes may be necessary. Dense material may need to be left to soak overnight. Care should be taken to avoid over-wetting as this can result in some materials, such as AIB ceiling tiles, collapsing.

Wet stripping in large industrial premises

7.36 Substantial amounts of asbestos lagging can be encountered in older, larger, heavier industrial premises and power stations. For example lagging in the boiler houses can be 1 m or more thick. These types of situations present certain challenges in obtaining effective control.

- The boiler houses may be large and complex with many passing pipes. Consequently, it may be difficult to obtain good enclosure. The size and complexity often means that a complete seal cannot be obtained and that negative pressure will not be achieved.
- The quantity and thickness of the asbestos lagging can make effective wetting difficult.
- Large quantities of asbestos waste and slurry may need to be handled.

Figure 7.15 Spraying thin coating



Whichever approach is taken, every effort should be made to ensure that the lagging is as uniformly wetted as possible before stripping. The size of the job should not be used as a reason for reducing the level of control

7.37 Where the building is redundant and ready for demolition, the relatively few people present in adjacent areas makes the job slightly easier. The building can be sealed off (in sections if appropriate) and local smoke testing carried out. This then allows the use of controlled wet stripping techniques, which can be sufficient to control exposure and the spread of asbestos fibres. Leak air sampling can be used to confirm that control is adequate.

7.38 Where there are people working in adjacent areas or it is difficult to achieve an adequate seal, additional precautions may be necessary. Smaller enclosures, within the main enclosure, can be built around the items to be stripped, and then put under negative pressure to provide an additional barrier to the main enclosure.

7.39 Whichever approach is taken, every effort should be made to ensure that the lagging is as uniformly wetted as possible before stripping. The size of the job should not be used as a reason for reducing the level of control. The large quantity of asbestos which needs to be removed can result in very high exposures, if controlled stripping techniques are not employed. The following technique can be used:

- The thickness of the material will often prevent wetting being achieved in one attempt. Wetting should be undertaken progressively. After any preparation work (eg removing any metal cladding), the lagging can be injected using the longest needles available, or liberally sprayed with a wetting agent, and allowed to soak. Wetting agent will only permeate the outer layer of the lagging. Once the outer material is wetted, it should be carefully removed until a reduction in the degree of wetting is noticed. The underlying lagging can then be injected or sprayed again, and the process repeated. Over time even the thickest lagging can be wetted in this way.
- The progressive removal of thick lagging will require more planning and organisation. Different areas should be able to be worked on simultaneously. One group of workers can wet an area of lagging, and a second group can subsequently strip the material while the first group prepares a new area. This system should maximise the speed of the work.

Close supervision is required to ensure the correct use of controlled stripping techniques

Some problems associated with wet stripping techniques

7.40 Wet stripping is not appropriate in some circumstances, because its use may introduce additional hazards, eg:

- in the presence of live electrical equipment that cannot be isolated or effectively sealed from water, although dielectric fluids can be used;
- where there is an unavoidable risk of contact between water and chemicals which may generate toxic or fire risks.

7.41 There are also situations where the use of wetting agents can cause problems, but these should not prevent the use of wet stripping techniques, eg:

- where wet work would lead to the discolouration of the fabric of the building, particularly where dyes are added to the wetting agent. The use of polythene sheeting on susceptible surfaces can prevent this;

Figure 7.16 Wrap-and-cut



- where wetting agents may cause skin problems. The manufacturer's or supplier's material safety data sheet should be consulted on the precautions to take;
- where a slip hazard may be introduced by spillage of the wetting solution. This can be reduced by placing drip trays or troughs under the area being treated, but these can be difficult to position to adequately collect the leaks. Alternatively, non-slip flooring could be used (and disposed of as asbestos waste). Any spills should be removed;
- if there are freezing weather conditions. Wetting agents can be treated to allow for this. Liquids are also available that work at up to 240°C, although hot work should be avoided.

Dry stripping with control at source

7.42 There may be some situations where it is not possible to use wet stripping techniques. In these circumstances, other methods should be used to control asbestos at source. Indeed, alternative techniques may be preferable in some cases. It is also worth noting that ventilated enclosures do not provide control at source. They do not regulate fibre release at the point of removal. Their primary purpose is to reduce the spread of asbestos.

Wrap-and-cut

7.43 In some circumstances it may be more appropriate to use the wrap-and-cut method (see Figure 7.16) rather than controlled wet stripping, eg the removal of redundant pipework and vessels. Wrap-and-cut is effective, as it eliminates the need for wholesale disturbance of the lagging. Consequently, the potential for fibre generation is much reduced. Wrap-and-cut is particularly suitable for pipework of small diameter (150 mm or less). If the lagging is damaged, wrapping and cutting can disturb and release fibres. Additional precautions will therefore be required (see paragraph 7.47). The RA should also consider manual handling risks during the removal of pipework/vessels.

7.44 This technique requires the lagged pipework or vessels to be securely wrapped in polythene sheeting before being cut out and disposed of as asbestos waste. The need for additional precautions such as enclosures, NPU's etc, should be determined in the assessment of work. Wrap-and-cut does not completely eliminate asbestos disturbance or release and, in many cases, fibre release will occur, eg in preparation work, where small sections of lagging have to be removed to allow cutting of the exposed pipework, or from disturbance of damaged areas of lagging. **In general terms, enclosures are required when the wrap-and-cut work is inside buildings, but may not be necessary when the work is external and remote.** Therefore, full consideration needs to be given on where wrap-and-cut can be used and on the need for an enclosure. Due to the potential for fibre release, enclosures will be likely in most cases. Chapter 6 provides further guidance on enclosure design and construction.

7.45 Wrap-and-cut is only suitable for lagged pipework or plant in certain circumstances:

- the items are redundant or are to be replaced;
- the items are manageable in size;
- the contents of the items have been removed;
- the items have been cleaned, where necessary, to remove residual hazardous materials.

7.46 It is important to only use this technique on manageable items. The handling of large or awkwardly shaped items of plant can result in injury or the ripping of the polythene sheeting. Also, it is worth noting that certain disposal sites may not accept wrapped items with large voids in them, eg a large calorifier.

7.47 The lagging should generally be in sound condition. If it is damaged, wrapping and cutting can disturb and release fibres. Additional precautions will therefore be required. The following methods, in isolation or combination, should be used to minimise fibre release.

- The lagging can be carefully treated with a penetrating encapsulant which will bind the fibres together. If the lagging is badly damaged, the possibility of fibre release during application will also need to be considered.
- The lagging can be wetted using injection or spraying with a wetting agent.
- Small areas of damage, adjacent to the area to be wrapped and cut, can be sealed with polythene sheeting and tape, and then worked on using localised spraying or shadow vacuuming.
- Where there are several areas of damage along a length of pipework, the entire run can be dampened using sprays and wrapped in polythene sheeting.
- Wrapped items too large to pass through the baglock should remain in the work area until the four-stage clearance has been completed and the enclosure removed. The items will be subject to the four-stage clearance process.

7.48 The pipework or plant should be divided off into manageable sections. For example pipework should be examined for suitable breaks in the lagging where flanges could be unbolted or pipe hangers removed, or the bare pipe cut, but without disturbing the asbestos. Where such breaks do not occur naturally, or if they are not at convenient positions, short sections of lagging will have to be removed. The size of the sections will also need to take account of the baglock exit arrangements and the dimensions of the skip. Removal of the asbestos will require control at source. The wet injection technique can be used (see paragraphs 7.20-7.30). Glovebag systems can also be useful for stripping short sections of pipework. Details are given in paragraphs 7.50-7.55. Take care to ensure sufficient lagging is removed to allow cutting/burning to take place, without disturbing the remaining asbestos. Once the pipe is ready for dividing or cutting, the lagging should be wrapped with heavy-duty polythene and the ends of the sections securely taped or otherwise sealed. The items should be labelled.

7.49 Pipework can be cut using a number of methods. Hacksaws can be used for very small diameter pipes. Abrasive cut-off wheels and flame-cutting techniques can be used on larger diameter pipework. In such situations, take care to avoid damaging the wrapped ends of the lagging. At least 20-30 cm of exposed pipework is required to reduce this risk. Where grinding wheels or flame cutting are used, the pipework should be wrapped in flame-retardant polythene sheeting (care should be taken when using oxyacetylene or oxypropane cutters, as this sheeting is not resistant to these). Vibration from the use of tools may also loosen asbestos on the remaining pipework. The wrapped sections of pipework should be carefully supported during cutting and/or unbolting, eg by sheet metal bands at sling attachment points. The pipework sections should be transferred to the skip as soon as reasonably practicable. Full PPE (including RPE) must be worn while this method of work is in use.

Glovebags

7.50 There are a number of proprietary glovebags, made of strong clear plastic materials, that are designed to allow stripping activities inside the bag by external operators using integral plastic gloves. The top part of a glovebag fits around the item to be stripped while the bottom part acts as storage for tools and asbestos waste. There are also versions available for removing ceiling tiles and sections of sprayed asbestos coating. Figures 7.17-7.18 show glovebags being used to remove a sprayed coating inside a traditional enclosure. It is important to note, however, that glovebags have certain drawbacks which prevent them from substituting for enclosures in many applications. The main concern is that there is no way to prevent asbestos spreading if there is a bag failure, eg through

Figure 7.17 A sprayed asbestos coating being removed using a specialised glovebag within a traditional enclosure (the dark area is where the asbestos has been removed)



Figure 7.18 A glovebag designed for the removal of sprayed asbestos coatings. Note the gloveports, waste chute and vacuum nozzle used for cleaning and providing slight negative pressure



punctures or from a seal failure.

7.51 Commercially available glovebags vary in strength of material (resistance to tears and punctures) and in design detail. Where reasonably practicable, the following design features should be considered when purchasing glovebags, to ensure that they can be used safely:

- they should be made from a material which does not tear;
- they should have shoulders of sufficient dimension to allow the glovebag to be effectively sealed to the pipe or vessel;
- they should have internal zips to allow the waste to be isolated at the bottom. This allows the top of the bag to be purged on completion of the work, minimising the release of fibres when the bag is removed;
- they should have an entry port for inserting a spray nozzle to wet the asbestos or a vacuum cleaner nozzle to create negative pressure and so purge the top of the bag on completion of the work.

Manufacturers should be consulted about the range and specification of bags which are available. They should help select the most appropriate design for the planned work and provide information on how to use them safely.

7.52 Enclosures will usually be needed even when glovebags are being used. Glovebags can **only** be used without an enclosure where the assessment shows minimal risks to other people if the glovebag leaks or fails. This may be the case where the site is remote from other workers, eg runs of open-air pipework in a chemical works where the prevailing weather conditions could make building and maintaining an enclosure impractical. However, you should note that there is still the potential for relatively low concentrations of fibre to leak out from the glovebag during use, especially through small holes. Consequently, the work area still needs to be segregated. **Glovebags should not be used in occupied areas without additional precautions, such as enclosures and NPUs.**

7.53 Where it is planned to use glovebags, the assessment carried out under regulation 6 of CAWR needs to address the following requirements:

- specific training is needed in the use of glovebags;
- the work area is well-defined; moveable items such as furniture are removed; ledges and other surfaces are covered in polythene sheeting;
- the glovebag should completely cover the section of pipe or other structure being worked on;
- asbestos debris on nearby surfaces can be dealt with safely;
- the glovebag is smoke-tested, eg by the use of a smoke tube;
- the operators wear suitable PPE, as determined by the assessment;
- where reasonably practicable, the work is carried out with the glovebag under slight negative pressure;
- wet stripping techniques, using wetting agents, are applied when reasonably practicable;
- the glovebag is only used once and not reused;
- the glovebag is not moved, ie slid along pipes;
- the glovebag is not used for jobs requiring more than two glovebags, unless the assessment shows that this is safe for the job in hand;
- the glovebag needs two operators to use it safely;
- contingency plans, and equipment for spillages and clean-up, are in place.

Where the assessment shows that these requirements cannot be met, the use of glovebags is not appropriate.

7.54 A variety of tools can be used inside the glovebag. A safe system of

removing the tools from the glovebag, without compromising the glovebag's integrity, should be drawn up. For example, the tools can be held in one hand within the glove of the glovebag, which is then pulled out. The glove can then be twisted to enclose the tools in a pouch. The twisted point can then be sealed at two points several centimetres apart. A cut can then be made between the two points, leaving the tools in the glove and the elbow or shoulder of the glove sealed to prevent any escape of fibres. The glove pouch can be placed in the next glovebag for use or in a container of water for cleaning.

7.55 There is wider scope for such bags as a supplementary measure inside enclosures. Where, in exceptional circumstances, controlled wet stripping cannot be used, the spread of dust can be largely eliminated by carrying out all the primary removal using glovebags within the enclosure. They may also have a role in final cleaning, where there are residues which prove hard to remove. The glovebag versions for overhead removal of ceiling tiles and sprayed asbestos coatings are also likely to be useful.

Direct removal by vacuum systems

7.56 Direct vacuum removal uses a combination of removing and vacuuming away asbestos material at source, by purpose-designed vacuum equipment. However, this method does not remove the need for an enclosure and other precautions. It is one method of removing loose asbestos which has been 'blown in dry' as thermal or noise insulation, and where wetting could cause the asbestos to bond to the underlying surface.

7.57 Waste asbestos is drawn from the stripping position to a remote collection unit by means of a vacuum transfer duct. This has the advantage that it considerably reduces the manual handling of waste, thereby saving time and expense, especially on large-scale jobs. Also, if adequate precautions are taken, the overall exposure is reduced.

7.58 Where this type of system is adopted, the assessment and POW should clearly identify the precautions to use and the procedures to follow in the event of problems such as blocked ducting, etc.

7.59 By its nature, this technique cannot be carried out with the asbestos wet. However, it can provide an equivalent level of control to that provided by controlled wet stripping, if the equipment is well-maintained and operated. Any residual material that remains after vacuuming can be wetted with a sprayed wetting agent, and then removed.

7.60 The technique has the disadvantage that a rapidly moving stream of dry asbestos material has to be transported, the asbestos material isolated and bagged. If the bagging unit is remote from the removal enclosure, it should be housed in a separate ventilated enclosure at negative pressure to prevent leaks, and treated as part of the stripping operation. Exhaust air should be filtered to a high standard before discharge (ie HEPA filtration). Since the waste material from the filters is also dry, rigorous precautions are required during disposal.

7.61 Because the bagging unit is handling quantities of dry loose asbestos moving at speed, there is the potential for high exposures if a leak occurs. Consequently, the assessment of the work under regulation 6 of CAWR should also address work in the enclosure containing the bagging unit. This enclosure normally needs to be constructed to the same standard as the stripping enclosure; it should be smoke-tested and have negative pressure applied. The number of workers in the enclosure, and the time spent in there, should be kept to a minimum. They should be issued with suitable PPE and RPE, as determined by the assessment. This protective equipment will normally be of the same high standard

as issued to the workers in the stripping enclosure. They should also follow the same decontamination procedures. Once the work is complete and the enclosure cleaned, it will be included in the four-stage clearance procedure (see paragraphs 7.102–7.145).

7.62 If the transfer ducting becomes blocked, it should be securely capped at both ends and drawn into the stripping enclosure, where it can be opened and cleared. Consideration and care are required when capping the end next to the vacuum equipment. It is important that where the ducting passes through the wall of the enclosure, any opening is immediately sealed. Where this is the case, work should be stopped and sufficient time allowed for the enclosure to be purged before drawing the ducting in.

Enhanced air management

7.63 Enhanced air management can be used for any type of stripping work. It is particularly helpful when controlled wetting or other controlled stripping techniques cannot be used. Because stripping may be carried out dry, with the potential for high exposures, it is very important to carefully plan and closely monitor the job. Only companies and individuals who have had specific training should use the technique.

7.64 With the technique, air is introduced by a blower unit close to the area of work and then the air is extracted at a higher rate to maintain negative pressure. The blower should be fitted with a manometer to detect changes in the negative pressure. If the negative pressure falls below a pre-determined level, the blower should automatically shut off and an in-built valve close, so that the pressure in the enclosure, relative to outside, cannot become positive.

7.65 To effectively reduce the exposure in the stripping area, the blower and negative pressure outlet points should be located close to the active work area and opposite each other, to draw the contaminated air away from the front of the worker. Push-pull of air independent of the enclosure negative pressure will improve control. However, the blower should not be located so close that it actively disperses the asbestos fibres, so making capture by the exhaust difficult. If the blower and negative pressure inlet points are too far from the active work area or located incorrectly, control of exposure will not be achieved. As the work progresses, the blower and negative pressure inlet points will need to be repositioned to ensure optimum efficiency. The workers should always try to be located to the side of the blower unit.

7.66 Because this is a complex system to operate and requires constant monitoring, it is mainly applicable when there are problems using other controlled stripping techniques. Where possible, the controlled stripping techniques previously described should be the first choice. Adopting enhanced air management does not exclude the use of other controlled stripping techniques.

7.67 Where other controlled techniques are used but the assessment indicates that high exposures may still occur, enhanced air management can be one way of providing additional control.

Asbestos stripping situations to avoid

Uncontrolled dry stripping

7.68 The term 'uncontrolled dry stripping' is applied to stripping ACM in its dry state within an enclosure, but without any direct controls to reduce exposure. Airborne asbestos fibre concentrations in these situations will be excessively high (up to 100-1000 f/ml for sprayed coatings) and will result in significant asbestos exposure even when strippers are wearing their normal high performance RPE. The RPE is unable to provide adequate protection for these fibre levels. In addition worker exposure will not be reduced to any extent through the air extraction in the enclosure. **Uncontrolled dry stripping is unacceptable and unnecessary. It must never take place.** Some form of control is always available whether it is direct control at source (eg wet stripping or shadow vacuuming) or other specialised techniques, such as glovebags or enhanced air management.

High-pressure water jetting

7.69 High-pressure water jetting has been used to remove asbestos from concrete floors, beams, and columns. It is a highly specialised technique which removes ACMs using water jets normally operating at pressures of about 138 bar (2000 psi) or above. This technique has a number of disadvantages, including:

- asbestos fibres are physically unable to absorb the water;
- a vast amount of virtually unmanageable slurry containing free asbestos fibres is produced; the slurry can be difficult to contain which leads to the spread of asbestos;
- the jet can cause serious injury;
- a mist of fine water droplets is formed which will wet the filters in RPE. This may affect the protection provided by the RPE, eg through increased breathing resistance or decreased airflow.

7.70 High-pressure water jetting is not controlled wet stripping, and it should only be used in exceptional circumstances and with specialist advice.

Power tools

7.71 Power tools have the potential to generate extremely high levels of asbestos fibres. There are numerous types of tools including drills, chisels, screwdrivers, sanders and disc cutters/angle-grinders. Where possible, their use on ACMs should be avoided and preference given to manual equipment, as it generally produces much lower dust levels. However, it is recognised that it may be necessary to use power tools in some circumstances. In these situations, the emphasis should still be on minimising fibre release. The tools should be used at their lowest possible setting and in conjunction with other control measures, such as shadow vacuuming and dust suppression materials (eg foams and pastes). In addition there may be occasions where more aggressive removal techniques are required, eg to remove residual minor amounts of textured coatings. Dust suppression (eg airless sprays) should be employed. Disc cutters and sanders should not be used to cut through or remove ACMs.

Hot working

7.72 The most likely source of heat will be from hot plant (eg boilers, calorifiers, pipework etc) either being worked on directly or located nearby. However, hot environments may arise from other sources, particularly due to weather conditions. High air temperatures and/or situations where there is direct sunlight (eg exposed enclosures) can cause elevated thermal conditions.

7.73 Working in hot conditions can cause a number of ill health effects ranging in severity, but including acute and potentially fatal conditions such as heat stroke. The range of effects is summarised in Box 7.3.

7.74 Hot working and asbestos removal are almost incompatible activities. There are fundamental issues which make asbestos and hot working extremely difficult to manage and control. In particular, the various precautions needed to protect workers from exposure to asbestos dust and to prevent its spread can result in a greatly increased thermal health risk. For example: PPE, RPE and enclosures all serve to prevent and restrict heat dissipation, and the PPE and RPE increases sweating and inhibits body cooling. Also, the implementation of a successful heat stress control regime (eg work/rest breaks, access to drinks etc) is impeded in asbestos enclosures, due to the complex entry and exit/decontamination procedures.

7.75 In addition to the heat stress issues, hot work can also lead to deterioration in asbestos control. For example: wetting of ACMs, particularly insulation on hot pipes, is more difficult to obtain; the integrity of the enclosure can be difficult to maintain as high temperatures and radiant heat soften polythene sheeting and weaken joints and seams; and in the event of a failure in the enclosure, strong convective currents can escape causing significant contamination of the surrounding area.

7.76 Therefore, hot work with asbestos is to be avoided where possible. All avenues should be explored to remove the heat source. Wherever possible hot plant should be shut down or turned off and allowed to cool before asbestos removal work begins. In many cases contractors and their clients have found that this is the quickest and most cost-effective way of dealing with the potential heat stress problems which can arise when asbestos removal work is attempted on hot plant.

7.77 Hot work will only be permissible in exceptional and fully justifiable circumstances and, as it must be notified on the FOD ASB5 form (see Appendix 3.1), it is likely to be challenged during notification. Work will only be allowed after an adequate RA has been performed (see paragraph 7.78) and where the thermal risks have been minimised in a well-planned and properly designed control regime (see paragraph 7.80). Where hot work is being considered, contractors may need to take specialised advice from an occupational hygienist or other consultant. Contractors may also wish to discuss the matter with the enforcing authority before proceeding.

7.78 The RA will need to be thorough and comprehensive. It will need to cover all the factors which affect heat stress. These include:

- working environment and conditions: air temperature, radiant heat, humidity, air movement, number/extent/location of heat sources, size/shape of premises etc;
- work rate: physical nature of the job;
- worker/personal factors: age, fitness, health status etc.

7.79 Every effort should be made to prevent the need for hot working. Work should be scheduled to be done during plant shutdown or annual holiday or in the evening or overnight when hot conditions are due to the climate. Where work arises at short notice through incidents or emergencies, then short-term remedial action should be taken as far as possible (eg by making temporary repairs or encapsulation) until the work can be incorporated into a programmed plant shutdown and carried out with the plant cold.

7.80 Where hot work is unavoidable then the thermal risks should be minimised through a well-planned and properly designed regime which should be based on the following:

- minimising heat sources: stopping all boilers and other process plant or equipment operating as far as possible and operating others at minimum temperatures, eg where there are two boilers, switch one off and operate the other at the lowest setting and then reverse the arrangement;
- minimising heat spread: through the use of temporary insulation (sacrificial lagging) to cover hot surfaces as they are stripped of existing insulation and through shielding radiant surfaces with low emissivity material or erection of radiant heat barriers;
- effective air management in the enclosure: employment of higher ventilation rates; removal of air at high level; location of the supply and extract vents to ensure a positive rate of air change at the working position;
- positive cooling in the enclosure: by drawing make-up from outside the heat-affected area or by the use of an air conditioning unit;
- localised cooling: the use of free-standing fans within the enclosure to provide local air movement at the working position (Note: care must be taken to avoid excessive air currents in the enclosure as they could cause disturbance of dust and could adversely affect the integrity of the enclosure);
- regulating the length of exposure through job rotation: it may be possible to rotate workers so that individual time spent in the hot area is minimised; implementing periodic rest breaks and rest facilities in cooler conditions (the work/rest ratio would depend on the conditions);
- preventing dehydration: providing cool water in the rest facility and encouraging workers to drink it in small amounts before work, during breaks and after work;
- providing training: covering the risks of heat stress associated with the work, symptoms to look out for, safe working practices and emergency procedures;
- providing adequate supervision: particular attention should be paid to ensure that the control regime is implemented and that it continues to operate satisfactorily for the duration of the work. Work/rest regimes should be strictly enforced;
- monitoring the thermal conditions and the health of workers: advice should be sought from occupational health professionals on a health monitoring regime.

Box 7.3: Health effects from working at high temperatures

- Burns: caused by contact with hot surfaces or by radiant heat.
- Superficial effects: swelling of feet and ankles, heat rash.
- Fainting: due to a reduction in blood pressure to the brain. This can be serious if the person is held upright or injured in a fall.
- Muscle cramps, nausea, vomiting: due to salt depletion caused by excessive sweating.
- Heat exhaustion: caused by dehydration due to excessive loss of sweat. Symptoms include: fatigue, giddiness, nausea, headache, breathing difficulties, extreme thirst, muscle cramps.
- Heat stroke: an acute and potentially fatal condition caused by a rise in body core temperature above 40°C. The condition may occur suddenly with no warning or may be preceded by headache, dizziness, confusion, faintness, restlessness or vomiting.

Site cleaning and preparation for four-stage clearance

Figure 7.19 A Type H vacuum cleaner



7.81 Regulation 16 of CAWR places a duty to ensure that the work areas and work equipment are kept in a clean state and are thoroughly cleaned. Employers should therefore use work methods and equipment which prevent or minimise the build-up of asbestos debris and waste on floors and surfaces in the work area. Where possible, the ACM should be placed directly into waste bags as it is removed. This is the most efficient arrangement and eliminates extra handling. In other situations employers must make sure that any asbestos dust and debris is cleaned up and removed regularly to prevent it accumulating and drying out where wet removal techniques have been used. There should be frequent cleaning throughout the work period and a clean at the end of each shift. Controlled wetting (eg using airless or light sprays) should be used to keep residues damp, particularly before bagging.

7.82 Cleaning methods should not create dust. Brushes or brooms should not be used for cleaning. Dust and debris should be dampened down as necessary before cleaning. Waste should be cleaned up using a combination of methods. Waste should be vacuumed up as far as possible. Type H vacuum cleaners which are designed to the British Standard (BS 5415)³¹ (the vacuuming specification for hazardous dusts) are the type which should be used with asbestos (but note paragraph 7.83). This equipment is fitted with a HEPA filter and is designed for dust-free disposal. Type H vacuum cleaners come with a range of attachments (brushes, narrow and broad slots) which allow their use on many types of surfaces and materials. Domestic or general purpose vacuum cleaners do not meet the required specification and should not be used. Pieces of debris can be cleaned up using rakes and shovels. Damp clothes and wipes should be used for additional cleaning of surfaces.

7.83 The type H vacuum cleaner should not be used on very wet material. Excessive liquid will damage the HEPA filter. Such material should be collected using rakes and shovels. However there may be occasions where there is a significant spillage of liquid or water. In these situations vacuum cleaners suitable for wet use can be employed, but only in a strictly controlled matter. The vacuum cleaner will need immediate cleaning and decontamination after use. In addition, arrangements should be made for safe removal and disposal of the filter.

7.84 Once the removal of the asbestos has been completed and all the waste and other non-essential items (tools, equipment, materials, etc) have been removed, the enclosure (ie work area) including airlocks and baglocks, is ready for the final clean and preparation for the four-stage clearance procedure. At this point, the pre-filters on the air extraction equipment should be replaced with new filters. The whole work area including all surfaces and items should be thoroughly cleaned using dustless methods. Fine dust will have settled or become attached to every possible surface in the work area. This includes floors, walls, all sides of sheeted items, high-level surfaces, pipes, ductwork, cables, undersides of items (pipes, ledges), behind and below plant, equipment and other furnishings and fittings (this list is not exhaustive). Every surface should be cleaned. Complete cleaning will be more easily achieved if it is carried out in a methodical and systematic manner. The type H vacuum cleaner should be used for the initial clean, with appropriate use made of the different attachments. The brush head attachment is particularly useful for uneven and rounded surfaces. Surfaces should then be wiped as necessary with damp cloths or wipes to ensure all fine settled dust has been removed.

7.85 At this point sheeting or boarding which has been used to protect any equipment, plant or other items or to protect surfaces, including sacrificial flooring, should be removed. It is acceptable, indeed sensible, to spray this sheeting with an adhesive sealant, eg PVA, before removal to reduce the potential for release

of residual fine settled dust. However, the use of the spray must be strictly limited to this sheeting and extreme care should be taken to prevent the spread of sealant onto other surfaces which would inhibit the issuing of the certificate of reoccupation. After removal of the protective sheeting, the underlying surfaces should be checked for any dust or debris which may have penetrated or settled on to them. The surfaces should be cleaned as appropriate.

7.86 Finally the contractor should carry out a thorough visual inspection to ensure that there has been complete removal of the ACM as planned and that the work area has been properly cleaned of visible debris and fine settled dust. All non-essential items should be removed from the work area. The only remaining items should be any wrapped waste that could not be removed through the baglock system, a type H vacuum cleaner and wipes and waste bags which may be necessary for additional cleaning as directed by the analyst and any equipment required by the analyst to perform the four-stage clearance procedure (eg ladders). A type H vacuum cleaner and buckets for decontamination should also remain in or around the airlock. Enough time should then be left to allow the work area to completely dry before the four-stage clearance procedure is carried out.

Disposal of asbestos waste

What is asbestos waste?

7.87 CAWR defines asbestos waste as being any amphibole or chrysotile product that has been removed from its original place of use. Therefore any asbestos product or material that has been removed from its original location should be treated as asbestos waste. This includes debris, dust and associated rubble and other mixtures where asbestos products are present. In England and Wales, the revised waste regulations²⁰ classify asbestos waste as 'hazardous waste'. In Scotland, asbestos waste is referred to as 'special waste' and is defined in practice as >0.1% asbestos (w/w).²¹ If there is any doubt about the presence of asbestos in waste, it should always be treated as 'hazardous' or 'special' waste.

7.88 Asbestos samples are not considered to be hazardous or special waste by the Environment Agency (EA) or the Scottish Environment Protection Agency (SEPA) until there is an intention to discard them. Samples should still be labelled in accordance with Schedule 2 of CAWR (see paragraph 7.91).

7.89 There are various other items that should be treated as asbestos waste. These include all enclosure building materials (such as timber and sheeting) and any items that have been present (and unprotected) inside contaminated areas and cannot or will not be cleaned (including tools and equipment). Asbestos waste items also include all disposable PPE used in the enclosure, transit and waste routes and in the hygiene unit. It also includes any disposable or discarded items used in cleaning and decontamination such as cloths, wipes and towels. Waste water from the buckets in airlocks should be disposed of through the filtered drainage system in the shower of the hygiene unit.

7.90 In England and Wales, premises that generate >200 kg of hazardous waste in a 12 month period have to be registered with the EA. This should be checked before work starts. Where <200 kg of hazardous waste is generated from each premises, contractors can register as a 'mobile service'. Contractors may also need to apply for a waste processing licence ('mobile plant licence') from the relevant environment agency (EA or SEPA) if removing ACMs from contaminated land. In addition the EA or SEPA should be contacted for advice if it is intended to reuse demolition rubble that is contaminated with ACMs.

Box 7.4 UN-approved asbestos waste packaging

It is the consignor's duty to ensure that dangerous substances are properly packaged and labelled.

'UN-approved' packages have been subjected to tests to ensure their suitability to withstand the handling associated with road transport. They will usually need to be used in double layers (eg red bag inside clear bag) and have specified means of closure (eg by PVC tape or 'swan necking' and taping). These details should be obtained from the supplier.

Typically, approval details will be marked in the following way:

 5H4/Yx/S/**/GB/abcd

5H4 is the code for plastic film bags
 Y indicates suitability for packing group II and III substances (covers both relevant UN numbers)
 x represents the maximum weight of contents in kg
 S means use for solids only
 ** last digits of year of manufacture
 GB is the country of certification (could be another country. Symbols match those for cars)
 abcd represents the certificate number

The bags should also be marked with the asbestos symbol (see Appendix 7.1) and the CDG hazard placard shown in Figure 7.21.

Box 7.5 Exemptions to the requirement for UN packaging

Special Exemption 168

This exemption applies when asbestos fibres are either bonded or contained in such a way that no fibres can become airborne in transit, namely:

- whole asbestos cement sheets that are transported in a sealed skip;
- articles with an asbestos component that cannot create airborne fibres in transit, eg a sealed fuse box containing asbestos rope or machinery with a sealed gasket;
- bonded materials such as bituminous floor tiles containing asbestos.

The limited quantity (LQ) exemptions

There are also specific exemptions from UN packaging requirements for small quantities of asbestos (less than 1 kg amphibole and less than 6 kg chrysotile). The exemptions allow asbestos to be carried in alternative 'fit for purpose' packaging.

How to package and label waste

7.91 Asbestos waste is subject to labelling and packaging requirements in accordance with Schedule 2 of CAWR and the Carriage of Dangerous Goods and Use of Transportable Pressure Equipment Regulations 2004 (CDG).³² CAWR requires asbestos items to be contained in 'sealed containers' which should bear the asbestos warning label, shown in Appendix 7.1. In addition, CDG requires all forms of asbestos to be contained in UN-approved packaging (as detailed in Box 7.4) unless they fall within the exemptions listed in Box 7.5.

Figure 7.20 UN-approved bags



7.92 In most cases, asbestos waste from licensed removal work will not qualify for the exemptions from CDG requirements. Therefore the waste should be double bagged using UN-approved packaging and placed in a sealed skip, freight container or locked vehicle. Standard practice is to use red inner bags and clear outer bags. The red bag contains the asbestos warning label. Bags should not be over-filled or contain sharp objects which may pierce the material. Approved packaging is available for up to 2 tonnes in capacity.

7.93 The following protocol should be followed for bagging (or wrapping):

- ensure that the waste material has been dampened down (in the case of AIB) or is wet (a doughy consistency for lagging materials);
- use waste bags directly beneath the work, and 'containment' sheets where these do not create other hazards;
- ensure that there are sufficient suitable UN-approved bags and/or polythene sheeting and means to seal the packages before work starts (see Figure 7.20);
- place the waste carefully into a red waste bag and seal with strong tape. Wipe down the red bag, place inside a clear asbestos waste bag and seal and clean in the same manner;
- if wrapping a large object which cannot fit into the asbestos waste bags, ensure that the item is wrapped in two layers of strong polythene and that a red asbestos waste bag or printed label (with the same information as the bag) is securely attached to the package to indicate that it is asbestos waste. The item must then be placed in a lockable skip or freight container;
- ensure that the specific waste decontamination procedures are followed. The procedures for cleaning waste bags or other wrapped waste are described in Box 7.6;
- ensure that the waste bags are transported to the skip or vehicle via the dedicated waste route;
- **do not take waste packages through the hygiene facilities;**
- make sure that your emergency procedures include a system for clearing up any spillages that occur when a waste bag bursts or becomes punctured either on site or in transit;
- asbestos-contaminated rubble or soil should not be carried 'loose' in a skip. This type of waste should be placed in large UN-approved bags (eg 2-tonne) and then placed in a lockable skip or freight container.

Box 7.6: Procedures for removing asbestos waste from the enclosure (see also Figure 6.8)

Waste bags (and wrapped items) must be decontaminated before they are removed from the enclosure. Decontamination will take place in the baglock system which forms part of the enclosure. In most situations (transiting and non-transiting), it should be performed in a three-stage baglock. The procedure should be as follows:

- the sealed waste bag (usually red and labelled) should be placed in the inner stage of the three-stage baglock;
- the bag should be wiped down and transferred into the middle stage of the baglock;
- the bag should be placed in a second bag (usually transparent), sealed and wiped down;
- the double-bagged waste should be placed in the outer stage of the three-stage baglock;
- the waste should be collected from the outer stage by the 'outside' worker and transferred to the waste skip.

Appropriate PPE should be worn by the outside worker (see paragraph 5.13). Where there is insufficient space for a dedicated three-stage baglock, the decontamination should be carried out in the alternative baglock arrangement. The design of the baglock will depend on the circumstances, eg transiting, non-transiting. Details are given in paragraph 6.22.

Transfer of waste to sealed skip or vehicle

7.94 Bags should not be overfilled. Once the waste packages are outside the baglock they should not be left unattended. All such waste should be kept secure. The best way to ensure this is to have a worker permanently based on the outside of the enclosure who does not need to decontaminate to take the waste to the skip or vehicle used for disposal. The skip or transport vehicle should be as close as possible to the enclosure to reduce the risk of the spread of contamination and the potential for musculoskeletal injuries. The following key points should be observed in relation to this part of the process:

- the 'outside worker' should wear appropriate PPE (ie RPE (eg FFP3), coveralls, gloves and footwear and wet weather gear, if necessary) when handling waste;
- keep the skip or vehicle locked;
- ensure the skip or vehicle is as close to the enclosure as possible;
- do not locate the skip or vehicle close to a sensitive area, eg in the middle of a school playground;
- ensure that there are no sharp objects placed in the skip. A sealed bulkhead should be provided in vehicles used to transfer waste to separate passengers from waste materials. Tools and other equipment should also be segregated to prevent bags etc being ruptured during transit;
- waste packages should not be thrown into the skip or vehicle. The route to the skip should be delineated, as this will form part of the clearance test at the end of the job;
- if there is no employee available on the outside of the enclosure to transfer waste to the skip or vehicle, then the person putting the waste through the baglock will have to carry out primary decontamination before taking the waste to the skip or vehicle (see Chapter 8 for details of personal decontamination).

Storage of asbestos waste

7.95 Asbestos waste can only be stored under the following circumstances:

- on site in a locked skip or locked vehicle;
- at a waste management facility, licensed or permitted by EA or SEPA.

Under no circumstances should asbestos waste be stored in an enclosure, airlock or the hygiene facilities

Transfer for disposal

7.96 Companies transporting waste should ensure that they comply with the relevant legislation and the guidance issued by EA and SEPA in relation to registering as a waste carrier and maintaining an auditable trail to show where the waste came from and its disposal point. All skips or freight containers holding asbestos waste should carry the asbestos symbol as shown in Appendix 7.1.

7.97 All loads should be made secure. It is good practice to have skips or freight containers that are regularly used for asbestos waste to be used exclusively for that purpose. HSE does not require them to be lined although they should be cleaned out to remove all visible debris once they have delivered their load to the licensed tip. Waste water from this process should be filtered and any residue should be disposed of as asbestos waste.

7.98 If a package or bag bursts during transit in a vehicle, sealed skip or freight container, the vehicle, container or skip will need to be cleaned out and visibly inspected before it can be reused. A vehicle would also require a disturbed air test to be carried out.

Carriage of dangerous goods requirements

The dangerous goods safety advisor

7.99 If a contractor is loading or transporting more than 333 kg of crocidolite or amosite (ie blue or brown) asbestos or 1000 kg of chrysotile (white) asbestos waste to which the CDG regulations apply, then a suitably trained transport of dangerous goods advisor will have to be appointed. The advisor should help to draw up procedures to load and/or transport waste, liaise with other safety advisors and write reports about any incidents involving the transport of the waste. This will apply to contractors who are registered waste carriers and transport waste in their own vehicle or who provide their own skip and skip lorry to transport waste to a licensed tip. If the work is sub-contracted to a registered waste carrier and the contractor only puts the packages into a sealed skip, a transport of dangerous goods advisor will not be required.

Transport rules

7.100 The CDG regulations require all fibrous waste to be transported under the conditions set out in the flowchart in Appendix 7.2 which is also summarised below:

- where the maximum weight of the vehicle exceeds 3.5 tonnes, the driver transporting the waste will need to have a dangerous goods Vocational Training Certificate (see *Are you involved in the carriage of dangerous goods by road or rail?*);³³ the vehicle will need to have suitable fire extinguishers; a 'Tremcard' (ie instructions in writing) (the information to be provided is listed in Appendix 7.3) should be carried in the vehicle cab; orange panels should be displayed on the front and rear of the vehicle and hazard placards (as shown in Figure 7.21) on all four sides of any skip loaded onto the vehicle;
- where the vehicle weight is less than 3.5 tonnes and more than 333 kg of crocidolite or amosite (ie blue or brown) asbestos or more than 1000 kg of

Figure 7.21 CDG hazard placard



chrysotile (white) asbestos is being carried, orange panels and hazard placards have to be displayed but the driver will not need dangerous goods training;

- where the vehicle's maximum weight is less than 3.5 tonnes, and less than 333 kg of amphibole and less than 1000 kg of chrysotile asbestos are carried, orange panels and hazard placards do not have to be displayed.

Environment Agencies' requirements

7.101 The Environmental Protection Act²² requires that a registered waste carrier is used for all construction and demolition waste. The nearest office of EA or SEPA should be contacted for further details of their administrative requirements. A list of regional offices can be found on the agencies' websites: www.sepa.org.uk and www.environment-agency.gov.uk. The key points for asbestos waste are given in Box 7.7.

Site assessment for reoccupation (Four-stage clearance procedure)

7.102 Following asbestos removal, the premises must be assessed to determine whether they are thoroughly clean and fit for reoccupation (or, as appropriate, demolition). Once the licensed contractor is satisfied that the area is clean and ready for future use, the area should be assessed by an independent organisation which is accredited by UKAS as complying with ISO 17025.³⁴ All air measurements should comply with the ISO 17025 standard. If this assessment of the workplace is passed as satisfactory, then a certificate of reoccupation is issued. The certificate is issued to the contractor and, as appropriate, to the client where the latter has engaged the analyst.

7.103 The clearance certification process is a vital component in asbestos removal work. The issue of a certificate of reoccupation by an impartial and competent organisation provides the crucial reassurance and security to the subsequent building users. The multi-stage certification process is designed to allow the inspection and assessment to be performed in a structured, systematic and consistent manner. The contractor should not arrange for the site clearance certification procedure to start until satisfied that the area is clean and dry.

Box 7.7 Waste: Key points

- Make sure that waste is properly bagged and/or wrapped with the appropriate UN-approved markings.
- Waste bags or packages should be removed through the baglock.
- Position the skip, container or vehicle as close to the enclosure as possible.
- Ensure that no sharp objects can burst bags or packages during transit.
- Ensure that the skip, container or vehicle is kept locked.
- All waste should be taken to a licensed or permitted waste management facility by a registered waste carrier and consigned appropriately.
- A waste processing licence may be needed for some waste management activities.
- In England and Wales the premises of asbestos waste generation must be registered as a hazardous waste producer with the EA before the waste is transported.
- You may require a transport of a dangerous goods advisor if you load and/or transport asbestos waste to which the CDG regulations apply.
- You can only store asbestos waste on site in a locked skip, container or vehicle or at a waste transfer station.
- Ensure that you have emergency procedures for clearing up any burst bags or packages.

7.104 The analyst and the contractor need to co-operate and support each other during this process. Each also needs to understand the respective roles and responsibilities. It is the responsibility of the contractor to thoroughly and diligently clean up the work area. The analyst's role is to provide independent verification that the area is clean and suitable for subsequent use. It is not the analyst's role to oversee the final clean of the area. It is the analyst's role during clearance certification to direct the contractor to those matters which require attention to ensure successful completion of the process. The analyst should allow sufficient time for clearance certification to be performed.

7.105 There are four stages to the site certification for reoccupation procedure:

Stage 1: Preliminary check of site condition and job completeness;

Stage 2: A thorough visual inspection inside the enclosure/work area;

Stage 3: Air monitoring;

Stage 4: Final assessment post-enclosure/work area dismantling.

Stage 1: Preliminary check of site condition and job completeness

7.106 Initially the analyst needs to establish with the contractor the scope of the work that has been carried out. This must be done by examining the contractors' POW.⁷ (Full information on contractors' plans of work is given in paragraphs 3.16-3.26). Regulation 7(2) of CAWR⁷ states that the POW should be kept at the premises until the work is completed. Paragraph 38 of *Work with asbestos insulation, asbestos coating and asbestos insulating board. Control of Asbestos at Work Regulations 2002. Approved Code of Practice and guidance*¹² states that the POW should be brought to the attention of anyone carrying out the four-stage certification procedure. It should be clear from the POW:

- where the asbestos to be removed was;
- if any asbestos materials were to remain in situ; and
- what the asbestos materials removed were.

7.107 If there is no POW on site or if the contractor refuses to make it available, **the inspection should either stop until such time as a POW is made available or a 'failed' certificate of reoccupation issued with the reason for the failure noted.**

7.108 The analyst should record the scope of the work on the site certificate for reoccupation. A diagram or photos should be appended so that the scope of the work is quite clear. A copy of the diagram from the contractor's POW would meet this requirement. If there is no diagram on site, the analyst should prepare a diagram. The diagram should contain the main features. It should show the enclosure (or work area) including airlocks and baglocks, transit and waste routes, and skip and hygiene facilities. It should provide details of sizes or dimensions. An example of a diagram is shown in Figure 7.22. The analyst and contractor should agree the content of the diagram and both should sign and date it.

7.109 When the scope of the work has been understood and verified, the analyst should ensure that the hygiene facilities are still intact, operational and clean. The clean end of the unit should be checked for cleanliness, hot and cold water and heating. The shower area and dirty end should be inspected either by external viewing (from the clean end in the case of the former) or by entering wearing the appropriate RPE and PPE. These areas should be clean and free from stored items and the NPU should be operating. The analyst should then check the surrounding areas to the enclosure, including the transit and waste routes, and the areas immediately adjacent to the enclosure (see also Boxes 7.8 and 7.9). The purpose of this inspection is to check for obvious signs of contamination arising from the work; either through leaks in the enclosure, burst waste bags or debris

from inadequate decontamination procedures. This inspection does not require the detailed visual examination which is necessary inside the enclosure or work area.

Figure 7.22 Recording of the site layout as a diagram, (a) shows the 3-dimensional layout and (b) is an example of how the site could be recorded as a clearance diagram. Dark areas show work areas and light areas show other areas which need to be inspected

(a)

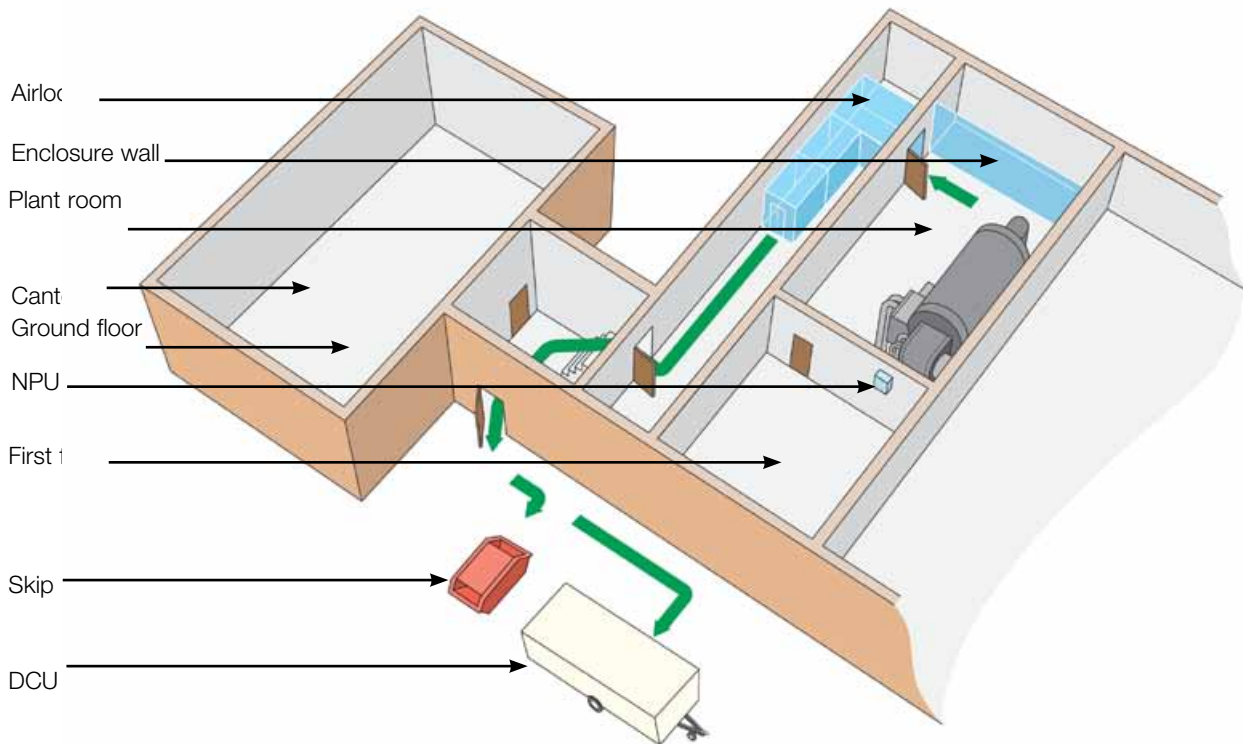

(b)

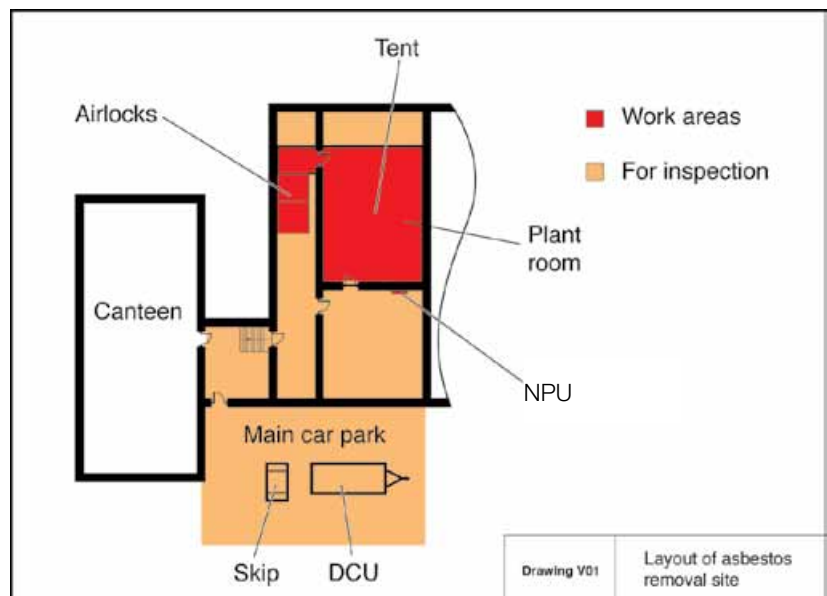

Box 7.8 Multi-job sites

Where there are several jobs ongoing at the same site, using, eg the same waste skip, it will not be possible for a Stage 1 inspection to be carried out in that area, as it is still being used. In this case the Stage 1 certificate should state why that area has not been inspected and clearly identify the area that has been inspected. This principle would apply wherever there are common areas still in use. Such information should be transparent and it should be recorded on the certificate of reoccupation.

7.110 The integrity of the enclosure should also be checked. If any asbestos debris is found in the surrounding areas it should be cleared up immediately by the contractors. Any breach in the integrity of the enclosure should be repaired before Stage 2 is started. The analyst should make sure that the air extraction equipment is in situ and in operation. Air extraction equipment should be switched off just before starting the Stage 3 air monitoring and should not be removed until the third stage of the site certification procedure has been completed and the enclosure is being dismantled. The pre-filters on the air extraction equipment should be replaced with new ones before the final clean by the contractors.

7.111 The analyst should examine the enclosure through the viewing panels (or CCTV monitor) before entering in order to gain an initial impression of the job completeness. Items to look out for include:

- waste remaining in the enclosure;
- visible debris on the surfaces;
- inadequate lighting to conduct a visual inspection;
- essential equipment such as ladders or scaffolding are still present so it is possible to inspect all areas;
- puddles of water, wet patches and leaking pipes;
- evidence that sealant has been applied to exposed surfaces;
- potential hazards inside the enclosure.

7.112 If any of these items need to be actioned, they should be dealt with before the enclosure is entered. The analyst should direct the contractor to the matters needing to be rectified. The analyst should also discuss with the contractor if any of the items were identified in the POW as needing special attention (eg ingress of water). The type of action needed to overcome these problems is given in paragraphs 7.123-7.130. The analyst must make a formal record of the scenarios encountered and the discussions and actions that took place to rectify them. If viewing inside the enclosure is not possible or is limited (viewing panels or cameras are either absent or are insufficient and do not allow views of all of the work area), a note of this should be made in the analyst's site record and the above items considered when entering the enclosure in Stage 2.

Box 7.9 Conditions where an inspection of the transit routes should take place

Conditions should allow the identification of obvious asbestos debris along transit and waste routes. Under normal circumstances, rain or damp ground should not prevent a Stage 1 inspection as the analyst is looking for visible debris, not fine settled dust. An inspection at night would not be a problem if the routes were well-lit. If, however, the analyst felt that conditions did not allow reasonable inspection, eg insufficient light, then it should be delayed until the conditions are suitable, eg the following day. In the very rare occurrences where a delay is likely to be significant, eg several days (eg due to snow covering), then the analyst should record the situation in the certificate of reoccupation and continue with the remaining clearance stages. The certificate of reoccupation should be issued as appropriate. However, the analyst and the contractor will have to return and complete Stage 1 (and Stage 4 if appropriate) as soon as possible after the conditions allow. The ACOP, *Work with asbestos insulation, asbestos coating and asbestos insulating board. Control of Asbestos at Work Regulations 2002. Approved Code of Practice and guidance*¹² provides for this variation from the norm in paragraph 157, where it states 'Site clearance certification should **normally** be carried out in four successive stages, with the next stage only being commenced when the previous one has been completed.'

If transit and waste routes are strewn with debris that could be mistaken for asbestos, or such that it is difficult to inspect for debris, the analyst should request that the routes be cleared to allow for adequate inspection.

The inspection is for obvious asbestos contamination and debris, not any other kind of debris.

There is no point in entering the enclosure until these problems have been rectified

7.113 Findings at Stage 1 should be recorded on the certificate of reoccupation and verified with the contractor before moving onto the second stage. There should be confirmation that the POW has been inspected and that the air extraction equipment, hygiene facilities and work areas are intact and operating. This stage should also contain a record of findings of the inspection of the skip/waste route, the transit route, hygiene facilities and the outside of the enclosure. A note should be made of any remaining asbestos that was outside the scope of the work.

7.114 Only when the analyst is satisfied with the Stage 1 inspection, should he/she enter the enclosure to carry out the Stage 2 inspection. The analyst should generally be entering an area that is free of all asbestos and should not normally be expected to have to undergo full decontamination on exiting the enclosure. However, if the site is found to have extensive debris and surface contamination remaining, it is important that the analyst terminates the Stage 2 visual inspection and leaves the enclosure before any significant disturbance or clean-up takes place. Failure to do this will mean the analyst could be contaminated by the contractors' activity and will need to follow full decontamination procedures on leaving the enclosure. Detailed information on decontamination procedures for analysts is given in *Asbestos: The analysts' guide for sampling, analysis and clearance procedures*.⁸

Figure 7.23 Analyst carrying out a visual inspection inside an enclosure



Stage 2: Thorough visual inspection inside the enclosure/work area

7.115 This is the stage at which the thorough visual inspection of the enclosure or work area takes place. It is the most significant part of the clearance procedure. The analyst must check:

- the completeness of the removal of the ACMs from the underlying surfaces;
- for the presence of any visible asbestos debris left inside the enclosure and airlocks or work area;
- for the presence of fine settled dust.

7.116 The removal process will have given rise to the spread of asbestos dust inside the enclosure. Residual dust may still remain on any unprotected or inadequately cleaned surfaces. Such dust presents an ongoing risk to building occupants. Therefore a thorough visual examination of all surfaces should be performed. It should involve a close and detailed inspection across all parts of the enclosure kneeling down or using ladders where appropriate (see Figure 7.23). All items should be checked. The inspection can be assisted by using a torch and by running a fingertip across the surfaces to check for presence of fine dust (see Figure 7.24). Awkward or difficult locations must not be excluded. Baglocks and airlocks should be included.

Figure 7.24 A torch being used to illuminate fine settled dust



7.117 The analyst should be accompanied during the thorough visual inspection by a representative of the contractor, who can rectify any minor problems found, such as:

- holes in the enclosure not visible from the outside;
- small amounts of dust or debris found during the course of the inspection.

7.118 The analyst will have to make judgements on the extent and significance of dust and debris found during the inspection: whether it is minor and can be cleaned up during the course of the inspection, or whether it is more substantial and is indicative that the final clean has not been undertaken thoroughly enough. It is important to remember that it is the duty of the contractor to undertake the final clean and carry out a thorough visual inspection before requesting a four-stage site certification for reoccupation. If it is clear that this has not been done, the analyst should withdraw and fail the enclosure, citing what needs to be done before another inspection is undertaken. The risk that the analyst undertaking an inspection will miss some contamination is increased if he/she has to stop and get cleaning done every few minutes. They should withdraw and let the contractors clean and re-inspect before starting a new visual inspection.

7.119 Essential equipment to be used inside the enclosure includes:

- a torch - the torch beam when shone along a surface at a shallow angle is useful in identifying fine settled dust on surfaces; it can also augment the lighting in the enclosure;
- a screwdriver - this is useful for poking behind pipes and into crevices to help inspect these difficult-to-see areas;
- a mirror - this can be useful in inspecting difficult-to-see areas.

7.120 Locations where asbestos dust and debris are commonly found during thorough visual inspections are shown in Figure 7.25. Asbestos dust and debris may also be found in the folds of sheeting used to construct the enclosure.

7.121 Equipment that must remain in the enclosure to help inspection includes:

- stepladders/scaffolding - depending on the height of the enclosure one or the other will be needed to allow safe access and to inspect the ledges, pipework etc above head height;
- lighting - a thorough inspection needs lighting; a torch alone is not enough. The torch should be used to supplement the background lighting, not replace it;
- vacuum cleaner and other cleaning materials - this will allow the contractor to clean any minor amounts of debris identified by the analyst immediately; a vacuum cleaner must also be available for preliminary decontamination on leaving the enclosure;
- buckets of water and sponges and brushes or wipes in the airlock to aid preliminary decontamination, following the visual inspection.

Figure 7.25 Boiler room showing locations where asbestos dust and debris are commonly found during a thorough visual inspection

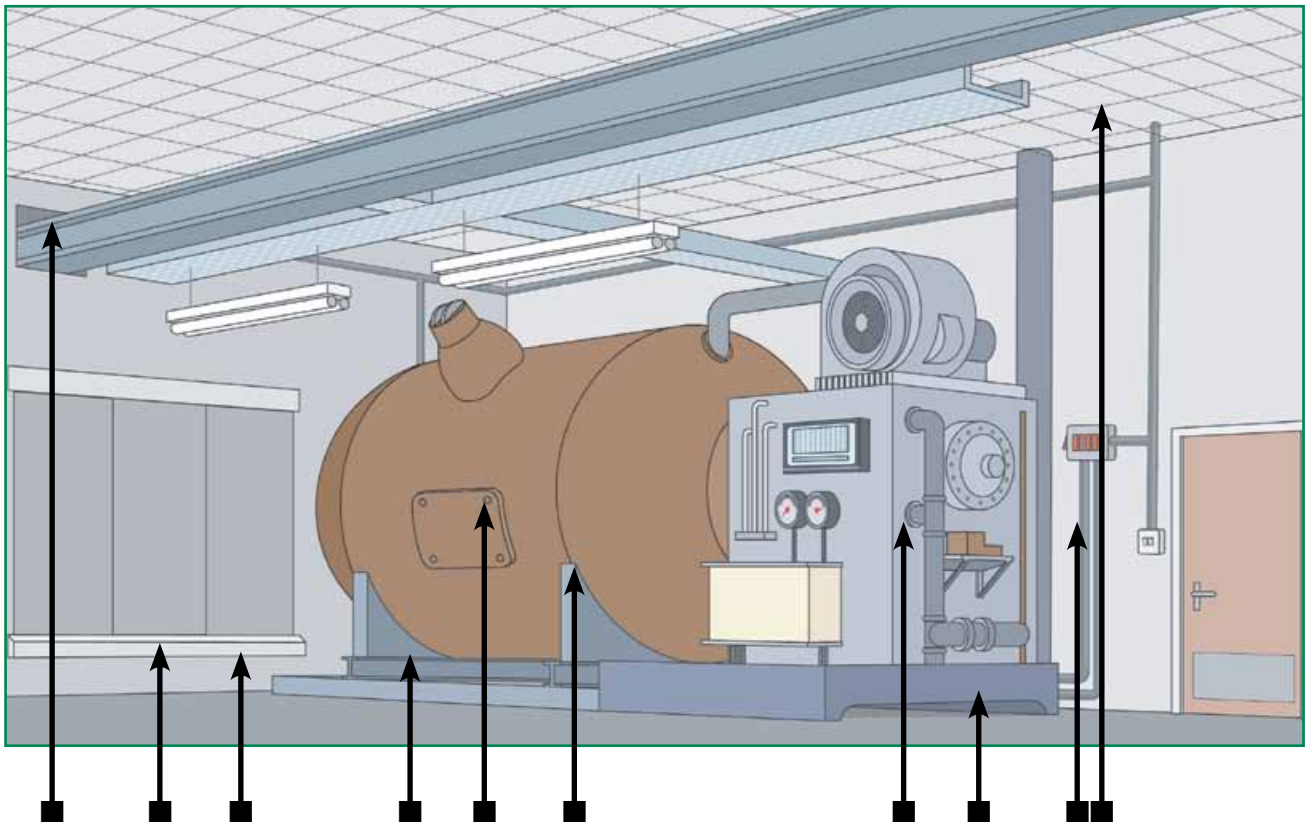

- 1 Backs of pipes and vessels
- 2 Support brackets and clamps on pipes and vessels
- 3 Nuts and bolts or flanges and hatches of vessels and pipework
- 4 Screw holes, or around nails and battens for AIB tiling
- 5 Cable trays and conduits, especially if they have a metal mesh construction
- 6 All horizontal ledges, shelves, window sills etc
- 7 The undersides of boilers and tanks, either attached or loose
- 8 Rough porous brickwork, eg breeze block and rough concrete
- 9 Holes in walls etc, where pipes, cables or steelwork pass through
- 10 Drains, sumps and culverts

How long should a visual inspection take?

7.122 The analyst must ensure that sufficient time is available for the visual inspection. A detailed visual inspection can be time-consuming, and the length of time needed will depend on the size and complexity of the job. A thorough visual search of all areas of the enclosure is required to be confident that an area is clean and free from asbestos debris and fine settled dust. A single panel removed from behind a domestic boiler within a 2 m² enclosure with smooth surfaces and nothing else within the enclosure is unlikely to take more than 10-15 minutes. Even a small boiler house should not take less than about 1.5 hours if inspected thoroughly. A large plant room, chemical plant or power station may take several days. During a large clearance, analysts should leave the enclosure, decontaminate and take a break every 2-3 hours. The time spent carrying out a visual inspection should be recorded.

Problems commonly encountered during visual inspections

7.123 Paragraphs 7.123-7.130 provide guidance on several issues which may be encountered during visual inspections. Potential problems can arise due to insufficient planning and preparation. Clearance should be considered by the contractor at the very outset of the job. There is a requirement for the contractor to consider clearance in the initial assessment of the work (ACOP, *Work with asbestos insulation, asbestos coating and asbestos insulating board. Control of Asbestos at Work Regulations 2002. Approved Code of Practice and guidance*,¹² paragraph 30). The contractor should be looking to identify those matters which will inhibit or impede clearance, eg wet enclosures, loose or naturally dusty surfaces, voids in ceilings which contain mineral wool, congested plant rooms which contain multiple pipes or equipment. These matters can normally be eliminated or resolved more easily before the work starts.

Wet enclosures

7.124 This is a problem commonly cited by analysts when undertaking clearances. The ACOP, *Work with asbestos insulation, asbestos coating and asbestos insulating board. Control of Asbestos at Work Regulations 2002. Approved Code of Practice and guidance*¹² states that an enclosure, where practical, should be clean and dry. However, the enclosure is sometimes wet. There are a variety of reasons for this: there may be a leaking pipe; sealant may have been sprayed in the enclosure; or there may be groundwater seeping through. If groundwater is present there may be little that can be done to render the enclosure completely dry, but it may be necessary for the contractor to use a pump to prevent the area flooding. However if there is a leaking pipe, there are two scenarios:

- If it is identified before work is carried out, it can be pointed out to the client and fixed before work begins. It can also be explained to the asbestos removal contractors that they will be unable to obtain a certificate of reoccupation if the leak is not fixed. If the situation is further complicated by the fact that the pipe is lagged with asbestos, then a preliminary removal job can be carried out. A small enclosure should be built and a section of lagging removed using a glovebag. This will allow plumbers to carry out their work once the area has obtained a certificate of reoccupation.
- If the leak is identified during the course of the work, work should cease and the area be cleaned. The plumber can then be accompanied into the enclosure by the contractor. The air extraction system should stay on. Plumbers should have suitable training in the use of the RPE and PPE to allow them to carry out their work safely. A leaking pipe should be no excuse for a wet enclosure.
An enclosure will fail a visual examination if it is wet and the cause is remediable.

Sprayed sealant

7.125 Paragraph 161 of the ACOP, *Work with asbestos insulation, asbestos coating and asbestos insulating board. Control of Asbestos at Work Regulations 2002. Approved Code of Practice and guidance*¹² also states that sealants should not be sprayed before a visual inspection or disturbed air tests. The only exception to this is where there is sufficient non-asbestos dust (eg from concrete) to cause a failure in the air test. The analyst has discretionary powers and, after due consideration and air testing, can allow sealant to be used in these circumstances (see paragraph 7.137). The circumstances should be recorded on the certificate of reoccupation and the air test should proceed. If an analyst arrives on site to carry out a visual inspection and the enclosure is still wet due to sealant being sprayed, the analyst must fail the area and inform the contractor that the Stage 2 inspection can only be carried out when the sealant has been washed off and the enclosure is dry. If the sealant has already dried, the analyst will have to fail the site and consider the way forward. If the evidence suggests that the sealant is protecting a significant amount of asbestos dust which will cause risk to subsequent occupants, then the sealant will have to be removed and the area recleaned. The client should be informed.

Enclosures with loose rubble flooring

7.126 The assessment should identify work areas where the flooring is loose rubble, eg in an undercroft. In these circumstances the rubble should be removed (to a specified depth) as part of a pre-clean of the site. The loose flooring would then be sealed with an impervious layer, eg metal or hardboard sheeting, before the asbestos work begins. If it was not possible to remove the rubble due to the condition of the remaining ACM or space limitations, then the matter should be addressed in the assessment. The POW should identify the procedure to remove the rubble and loose soil after the ACM removal has been carried out. In these circumstances, it would be prudent for the contractor to consult with the analyst before starting the work. If an analyst arrives on site to carry out the four-stage clearance certification, without prior discussion and agreement of the procedures for clearance, it will be impossible to pass such an area according to the standard required in a Stage 2 inspection. The analyst will have to fail the site and liaise with the contractor and/or client to organise the removal of a specified depth of the rubble/loose flooring before the formal inspection begins. The depth of rubble to be removed will depend on the level of contamination. The analyst can then check the remaining flooring for signs of asbestos contamination. If the analyst is satisfied that the contamination has been removed, the flooring can then be sealed and Stage 2 visual can formally start.

Asbestos remaining in enclosures (by design)

7.127 There may be occasions when some asbestos is to remain in situ in the enclosure. It may be that only damaged asbestos lagging is being removed from pipework, and that undamaged material is to remain; or it could be that asbestos ceiling tiles are being removed, but a fire door with an asbestos cement panel is being left in place. In these circumstances the ACM should be labelled that it is asbestos and that it is to remain. The item can then be checked by the analyst against the work plan and recorded on the certificate of reoccupation.

Asbestos waste remaining in enclosure

7.128 On occasions, it may be necessary to retain asbestos waste (bagged or wrapped) within the enclosure until Stage 4 of clearance certification starts and the enclosure can be removed. This situation may arise when oversized waste (such as lengths of pipework or large AIB panels) cannot be removed through the baglock system. The items should remain in the enclosure and be subject to inspection along with other items to make sure they are free of asbestos debris on the outside of the wrapping. The items will also need to be moved to allow the analyst to inspect the underlying surfaces.

Inaccessible asbestos

7.129 Where asbestos has been spray applied, there are often crevices or holes through walls where pipe work or girders run. These may contain asbestos but are impossible to clean so that all asbestos is removed. In these cases, the analyst may permit the use of non-flammable sealant such as foams or plaster to fill the hole and seal the asbestos within it. However, the analyst should be satisfied that as far as reasonably practicable, the asbestos has been removed before the sealant is applied. The client for the contract (eg building occupier) should be informed that this is the proposed course of action before the encapsulation takes place. It should be in the POW. The location of the sealant and remaining asbestos should be noted on the certificate of reoccupation, so that the client can record the presence of the asbestos in the management plan. If an analyst arrives on site to find that holes around the area where the sprayed asbestos was applied have been plugged with foam or other sealant, the contractor should be instructed to remove the sealant before the Stage 2 inspection begins.

Use of encapsulant and sealant

7.130 Where asbestos has been sprayed onto porous surfaces (eg breeze blocks) or onto tar, it is almost impossible to remove all the asbestos, sufficient to pass a visual inspection (see Figure 7.26). In these cases the analysts, having satisfied themselves that further removal is not reasonably practicable, should advise the contractor and/or client to seal the residual asbestos with a permanent proprietary sealant. The visual inspection can then begin again once the sealant has been applied and dried. Encapsulation of asbestos in these instances should not take place before the analyst has seen the residual asbestos.

7.131 The findings of Stage 2 of the inspection should be recorded on the certificate of reoccupation. There should be confirmation that the airlocks and enclosure are free from visible debris and contamination, that all ACMs have been removed and that the interior surfaces of the enclosure are free from visible debris and settled dust. As for Stage 1, if problems are encountered during the Stage 2 inspection, the analyst must make a formal record of the scenarios encountered and the discussions and actions that took place to rectify them. The analyst should also make specific comments on the certificate of reoccupation if any asbestos is to remain (see paragraphs 7.128-7.129) and clearly identify the locations of these areas with a recommendation that this information should be entered into the management plan/asbestos register.

Figure 7.26 Remnants of asbestos on breeze blocks



Figure 7.27 Air sampling during clearance



Stage 3: Clearance indicator air sampling for the certificate of reoccupation

7.132 Air sampling takes place once a thorough visual inspection has been carried out and the analyst is satisfied that all the asbestos in the POW has been removed, and there is no visible debris or layers of settled dust (see Figure 7.27). The lowest airborne respirable asbestos concentration that the method described in *Asbestos: The analysts' guide for sampling, analysis and clearance procedures*⁸ can reliably quantify is 0.01 fibres/ml, for a sample volume of at least 480 litres passed through a filter with an effective diameter greater than 20 mm. In most cases it is reasonably practicable to clean the working area thoroughly enough for the respirable airborne fibre concentration after final cleaning to be below that limit, using the approved measuring method. Therefore a value of 0.01 fibres/ml is taken as the 'clearance indicator' threshold, and a site should not normally be regarded as fit for reoccupation until the asbestos in air measurements are below this level.

7.133 Details of the equipment to be used to carry out the sampling and analysis are given in *Asbestos: The analysts' guide for sampling, analysis and clearance procedures*.⁸ The strategy for sampling and dust disturbance and sample analysis are also given in *Asbestos: The analysts' guide for sampling, analysis and clearance procedures*.⁸ Air sampling should be accompanied by sweeping the floor with a

broom and brushing the surface from which the asbestos was removed and any other higher level horizontal surfaces (see Figure 7.28). Brushing should also take place on horizontal surfaces where the dust may have settled or collected or where there is suspicion of surface contamination, and on surfaces in close proximity to the sampling equipment. The broom and/or brush used should be made out of man-made fibre and should be used to give a representative simulation of cleaning activity. For enclosures with floor areas greater than 20 m² a long-handled broom should be used to sweep the floor, for both ergonomic and practical reasons.

7.134 The dust disturbance should be carried out as described in paragraphs 7.135-7.136. The dust-raising activities undertaken and their duration should be recorded on the certificate of reoccupation. On some surfaces, brushing may generate significant amounts of particulate which may obscure the filter. If this is the case, sampling strategies may need to be modified to take this into account. Appropriate PPE should be worn by the person conducting the disturbance test.

7.135 The purpose of the disturbance activity is to ensure that workers, occupants, cleaners and members of the public using the area in the future are not exposed to asbestos as a result of ineffective removal and cleaning. A realistic simulation of a possible future activity that may produce high airborne dust and fibre concentrations is the brushing or sweeping of surfaces. Brushing should be carried out in a manner that is consistent with normal cleaning activities in a building. Brushing should take place in all of the following locations: all surfaces from where the asbestos has been removed, horizontal surfaces where the dust may have settled or collected or where there is suspicion of surface contamination, and surfaces in close proximity to the sampling equipment. These dust-raising activities should be substantial enough to raise fine settled dust (if it is present) from surfaces, and should be commensurate with the size of the enclosure. They should take place for a duration of at least 1.5 minutes for each measurement point inside the enclosure, near the start of each full hour of sampling, or each time a new filter is used in an area. For larger enclosures there is likely to be more than one person carrying out the dust disturbance work, so the same total surface area will be disturbed but in less time. This means the total time of the disturbance is unlikely to exceed around 10-15 minutes each hour.

7.136 All brushes used for raising dust should be considered as being contaminated and should generally be disposed of as asbestos waste. However some brushes may have detachable screw handles. Where the handle is constructed from a material which could be effectively decontaminated (eg plastic) then this part may be reused after thorough cleaning. Brush heads, irrespective of the composition, should always be disposed of as asbestos waste.

Dusty enclosures

7.137 There may be occasions when the surface in the work area is a source of non-asbestos dust that would generate unreadable filters. The presence of non-asbestos dust would be noted at the thorough visual inspection. The analyst has to be satisfied that the dust is non-asbestos. However, the analyst should proceed with air sampling as normal. If this produces unreadable filters, the analyst should consider sampling for shorter periods with paired samplers, so that the dust loading on each filter is reduced. If the samples fail again because of the dust loading, then the spraying of surfaces with a sealant should be considered. If a sealant is used, the air test should not be carried out until the sealant is dry (see paragraph 7.125).

Figure 7.28 Analyst carrying out disturbance by brushing during clearance



Assessment of air sampling results

7.138 After air sampling, the analyst will check the final flow rate and collect samples for phase contrast microscopy analysis. The analyst will count the fibres in a minimum of 200 graticule areas and report the calculated fibre concentrations for each sample. The analyst will also produce a clear statement whether the enclosure has passed or failed, relative to the clearance indicator value (0.01 f/ml).

Leaks in enclosures

7.139 Under normal circumstances, the air extraction equipment should be turned off and capped during the air test. The analyst should check that the pre-filter was changed before the final clean. However, if, in the opinion of the analyst, switching the air extraction system off would compromise the integrity of the enclosure, and there are people near the enclosure who may be exposed to airborne asbestos fibres above the clearance indicator as a consequence, the analyst can direct the contractors to leave the system switched on during the air test. Any decision to leave the air extraction system switched on should be recorded, with reasons why, on the certificate of reoccupation.

Stage 4: Final assessment post-enclosure/work area dismantling

7.140 Once the enclosure (or work area) has passed the visual inspection (Stage 2) and air monitoring (Stage 3), the enclosure can be dismantled. Under normal circumstances, the analyst will probably remain on site during dismantling (unless the deconstruction is not to take place for some time). If the analyst is close to the dismantling work, appropriate PPE should be worn as trapped pockets of asbestos could be released during the physical disturbance. Reassurance sampling could be carried out during the dismantling procedure to check for any release of airborne asbestos. After the enclosure has been removed, the analyst should visually inspect the area to ensure it is clean. At this stage the analyst is looking for obvious asbestos debris such as from the sheeting of the enclosure as it was dismantled or from debris which has been missed during cleaning. The analyst should also re-inspect the waste route and transit route for asbestos debris.

7.141 Where there is some debris, this can be cleaned by the contractor's employees, wearing appropriate PPE including RPE, immediately using a type H vacuum and wiped with a wet disposable cloth. If the area is too contaminated to allow immediate cleaning without the prospect of spreading contamination, the site should be failed, re-enclosed, re-cleaned, and the visual inspection and disturbed air test repeated.

7.142 If there are fuse boxes or switches within the area and the analyst suspects they may be contaminated, a qualified electrician should be made available to isolate the boxes, so they can be inspected.

7.143 The analyst should record what has been inspected, what was found and the outcome on the certificate of reoccupation.

Certificate of reoccupation

7.144 Once all four stages of the clearance procedure have been completed satisfactorily, the analyst should issue a certificate of reoccupation. Each stage of the certification should have been completed in sequence, to ensure that the information included is as complete as possible. The information should be clear and unambiguous so all parties know the scope and extent of clearance and any particular matters which have been dealt with.

7.145 A template for a certificate of reoccupation setting out the details it should contain can be found in *Asbestos: The analysts' guide for sampling, analysis and clearance procedures*⁸ (Appendix 3). If one of the stages fails, the reasons for the failure should be entered and the remaining stages struck through. A signed

acknowledgement of the failure should be obtained from the contractor's site representative (usually the site supervisor). If the failure occurs at either Stage 1 or 2 of the process, the inspections (both Stage 1 and Stage 2) will need to be repeated. If a new analyst carries out the work, the whole procedure should start again. If the site fails at Stage 3 or 4, it is only necessary to repeat these stages until both have passed. The analyst will then need to cross-refer to, and append the certificate where the Stages 1 and 2 were passed. It is very important that the contractor's representative acknowledges the outcome on each certificate issued, whether for a pass or a failure, as this provides evidence of when the outcome was communicated. The certificate will provide documentary evidence of the work undertaken by the analyst and should be retained by the analyst. Copies of each certificate must be issued to the contractor and, as necessary, to the client employing the analyst. This may be done after the analyst has left the site, provided the contractor's representative has acknowledged the outcome. Each certificate should bear a unique number.

Inspection certificate for the hygiene facilities

7.146 Once the certificate of reoccupation has been issued, the analyst can begin the clearance of the hygiene facility. This should be inspected and air tested. The air test should be accompanied by disturbance of surfaces in the dirty and shower areas. Obviously there is no requirement for a four-stage certification procedure here, as Stages 1 and 4 are carried out as part of the main certification for reoccupation. Only Stages 2 and 3 of the procedure are required.

7.147 The hygiene facility should be clean and dry before the inspection takes place and any potentially asbestos-contaminated materials removed (eg bags containing used coveralls, used/discarded respirator filters, transit clothing). It is recommended that the unit is entered through the clean end to check that this area is clean and free of bagged materials, before carrying out a detailed clearance in the shower area and dirty end. The clearance should be carried out using the same criteria as for enclosures. If the inspection shows that no dust and debris are present, clearance air sampling should be carried out in the shower area and dirty end. For very small units where the combined floor area of the shower and dirty areas is less than 10 m², one air test is sufficient if the door between the shower and dirty areas is propped open and the sample head is positioned in the doorway. Where the combined floor area of the shower and dirty end exceeds 10 m², a sample in each of the shower and dirty areas should be taken. A minimum air volume of 480 litres should be sampled for each sample. During air sampling, the extraction in the hygiene facility should be switched off and capped and surface disturbance should be carried out using a brush for 1.5 minutes for each sample. A separate inspection certificate should be issued for the hygiene facility. The hygiene facility should normally be subjected to the inspection and air sampling before it is moved off-site (see paragraph 7.147). The analyst should review with the contractor whether or not the hygiene facility is to remain on site following the issue of the inspection certificate and a note of this made on the certificate.

7.148 Where, for security reasons, hygiene facilities are not left on site overnight, inspection certification is not required until the end of the contract. In these situations, information on where the hygiene facility is to be stored overnight and other arrangements should be included in the POW sent to HSE with the ASB5 notification. Further information on this can be found in paragraph 8.40.

APPENDIX 7.1: LABELLING REQUIREMENTS FOR PLASTIC BAGS/SACKS CONTAINING ASBESTOS WASTE

Waste blue asbestos (crocidolite) UN 2212

Waste brown asbestos (amosite) UN 2212

Waste white asbestos (chrysotile) UN 2590

Carriage of Dangerous Goods and Use of Transportable Pressure Equipment Regulations 2004.³²

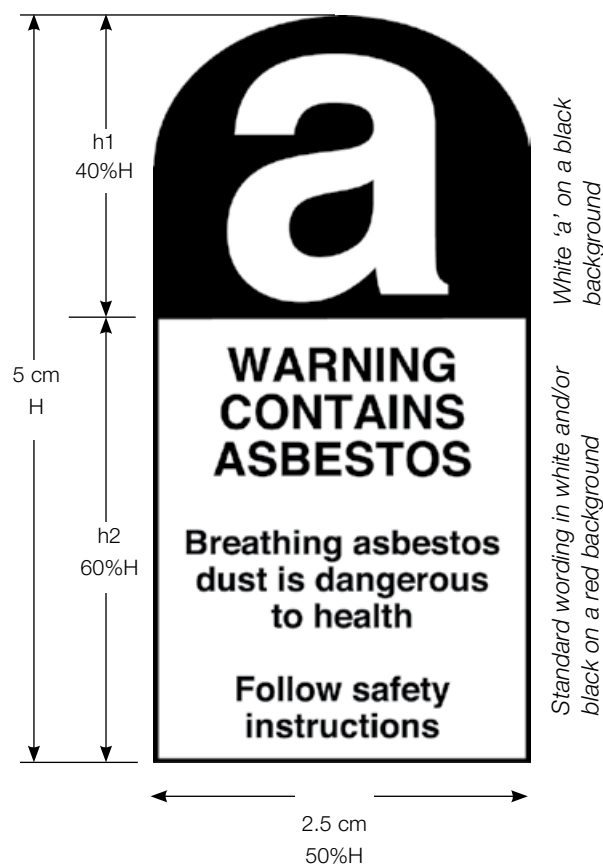

The dimensions in millimetres of the label shall be those shown on the diagram, except that larger measurements may be used, but in that case the dimension of the label indicated as h , on the diagram above, shall be 40% of the dimension indicated as H on that diagram.

The label shall be clearly and indelibly printed, so that the words in the lower half of the label can be easily read, and those words shall be printed in black or white.

APPENDIX 7.2: ASBESTOS WASTE FLOW CHARTS

Procedure for dealing with asbestos waste

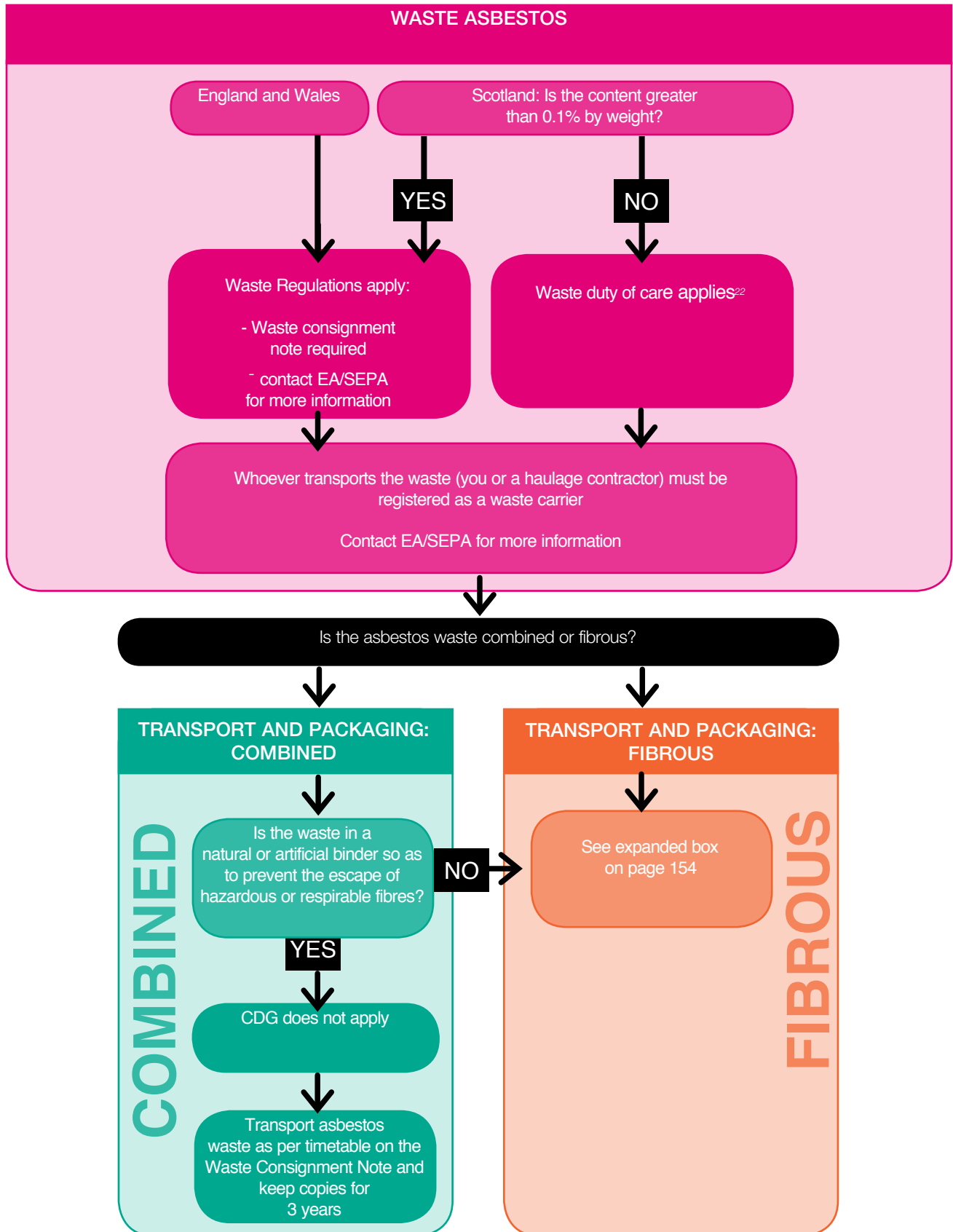

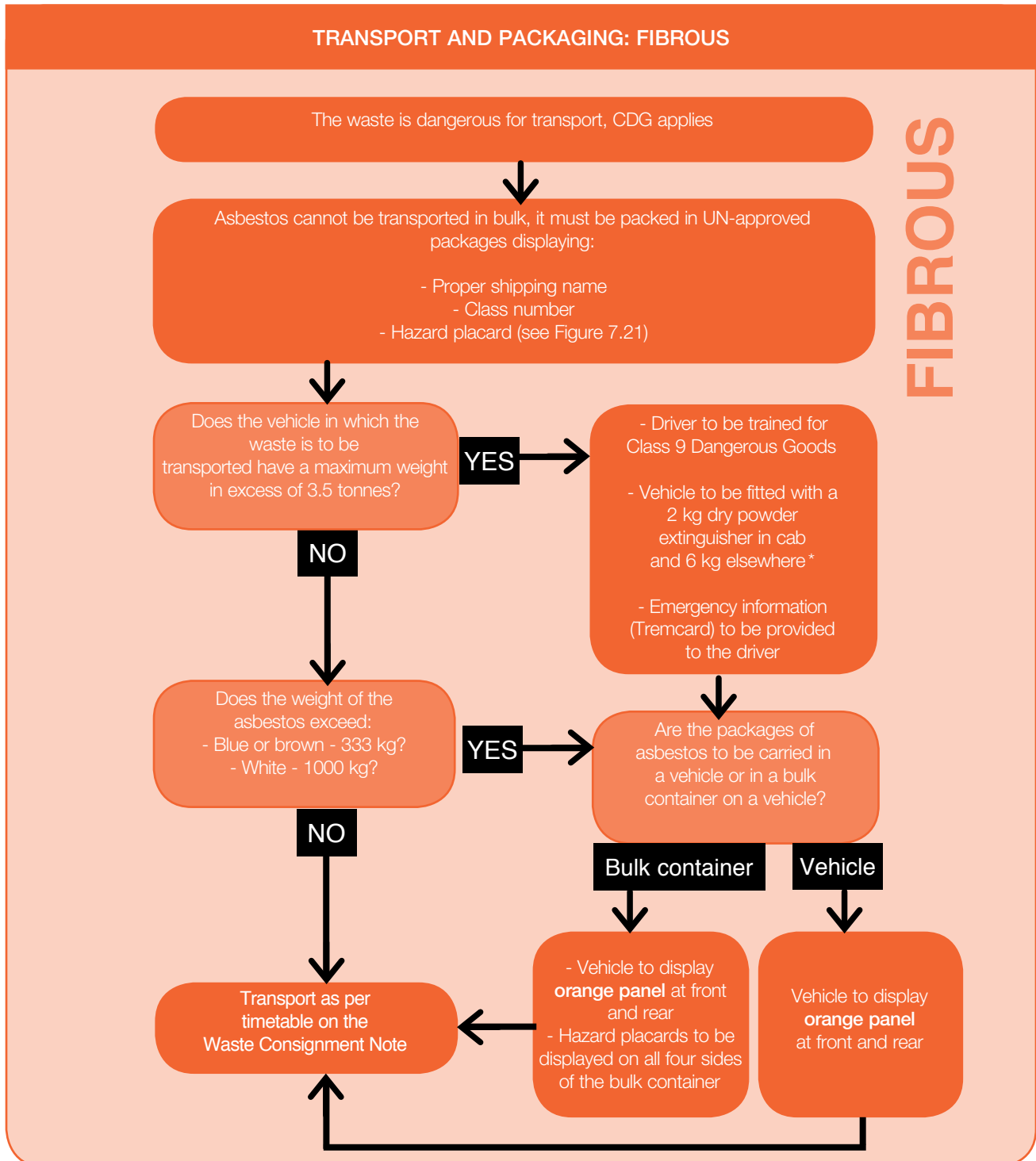

Waste Consignment Note to be kept by the consignor for three years.
Other documentation to be kept by the operator for three months.

* Vehicles <3.5 tonnes: 2 kg in cab and 2 kg elsewhere

APPENDIX 7.3: ASBESTOS WASTE 'INSTRUCTIONS IN WAITING' (TREM CARD) INFORMATION

The following information should be provided by the consignor (contractor) to the consignee (tip operator):

- The name of the dangerous goods, ie white, blue or brown asbestos.
- The class of dangerous goods, ie Class 9.
- The UN number, 2212, white asbestos; 2212, brown asbestos and 2590 for blue asbestos.
- The packing group, Group III for blue and brown asbestos and Group II for white asbestos.
- The mass or volume of goods to be carried.
- The transport category, Category 2 for blue and brown asbestos and Category 3 for white asbestos.
- A declaration to say that the goods are properly labelled and in a fit condition to be carried.
- The names and addresses of the consignor and the consignee.
- Any other information that will enable the goods to be carried safely.

Chapter 8: Decontamination



Summary

- Failure to decontaminate properly may lead to the spread of asbestos and delay the four-stage clearance process.
- DCUs should meet the design criteria in Appendix 8.1.
- The DCU should be on site before work starts and it should be the last thing to leave site.
- Employees should follow the decontamination procedures shown in Figures 8.8-8.12.
- The supervisor has a vital role in ensuring that procedures are followed and that maintenance and regular site checks are carried out.

Contents

Introduction 158

The decontamination process 159

What does the decontamination process involve? 160

Training in decontamination procedures 163

Monitoring of the decontamination process 163

Emergency procedures 163

DCUs 163

The different types of DCU 163

Connections to services 164

Provision of information 165

Maintenance and cleaning of hygiene facilities 166

Inspection and cleaning 166

Maintenance 166

Thorough examination and testing 166

Record-keeping 167

Showering and laundering 168

Laundering of coveralls and towels 168

Laundry operators 169

Appendix 8.1: Minimum design criteria for asbestos hygiene units 171

Introduction

8.1 All personnel (workers and others) who enter enclosures or designated work areas are likely to become contaminated with asbestos and therefore need to decontaminate themselves when they leave. The purpose of decontamination is to ensure that the workers clean themselves and their PPE and RPE to prevent the spread of asbestos outside the enclosure. In addition, the decontamination procedure is designed to ensure that cleaning is performed in such a way that it does not lead to secondary exposure for the worker. This chapter describes the decontamination procedures that should be carried out every time workers leave the enclosure. The chapter also specifies the enclosure entry procedures for workers and it describes the arrangements for laundering towels and coveralls.

8.2 Decontamination consists of three stages:

Stage 1: Prevent or minimise contamination inside the enclosure, ie avoid becoming contaminated. Prevention is the most effective action. Its importance cannot be over-emphasised. Work should be carried out in such a way that minimal dust and debris are produced. This will not only minimise the extent of contamination on PPE and RPE, it will also reduce exposure and the spread of asbestos.

Stage 2: Preliminary decontamination within the enclosure and airlocks. The bulk of contamination should be removed from PPE and RPE at this stage.

Stage 3: Final decontamination within the DCU. The remaining residual contamination is removed and workers change back into domestic clothing. This three-stage structured approach to decontamination allows the process to be conducted systematically and consistently. Workers should follow the same series of steps every time they leave the enclosure.

Figure 8.1 General layout of a hygiene unit

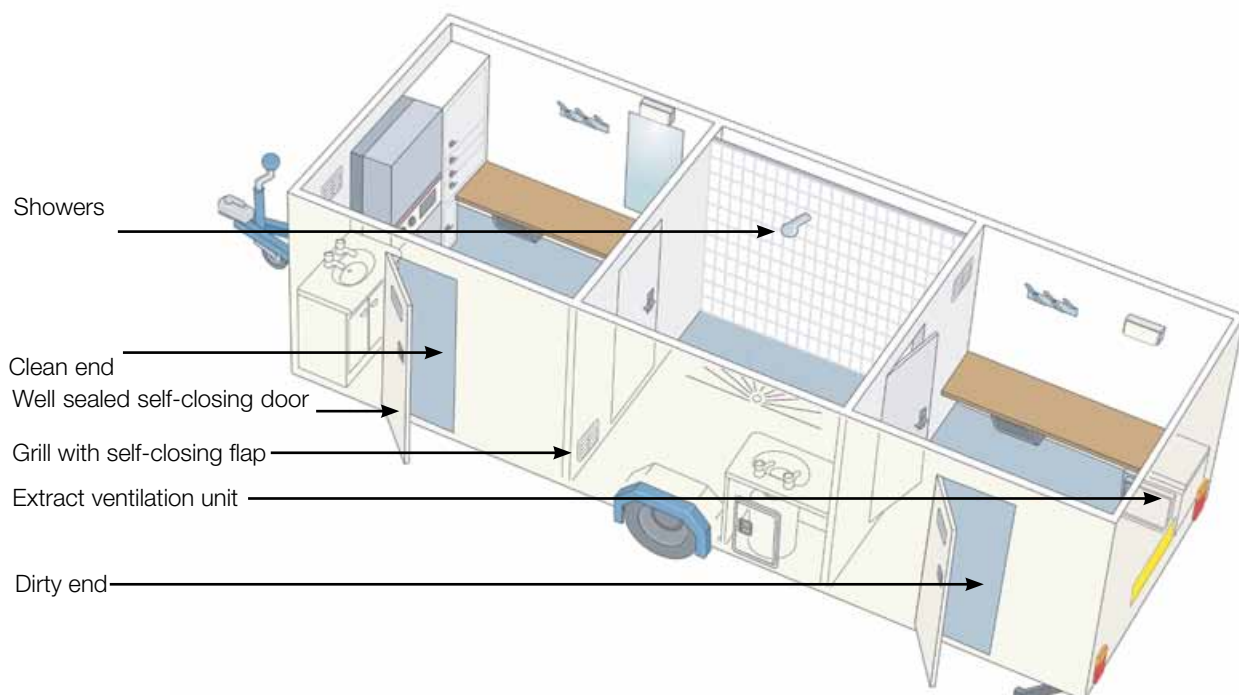

8.3 The main decontamination facility (referred to as a hygiene unit or DCU) is a fundamental component in the worker cleaning process. The DCU can be a mobile, fixed or modular facility. It allows workers to prepare for work (by changing from their domestic clothing into their PPE and RPE) and it provides the facilities to carry out the final stage of decontamination after exiting the enclosure. The design and specification of hygiene units are extremely important. Hygiene units must meet the minimum design criteria and specification set out in Appendix 8.1. Figure 8.1 shows the layout of a typical hygiene unit.

The decontamination process

8.4 The provision of hygiene units is essential for licensed asbestos work. Arrangements should be made to ensure that the DCU is on site and functioning at the very start of the job. It should be available on site for pre-clean work and for situations where scaffolding erection is liable to disturb asbestos, and it should be available before the enclosure is built. The hygiene unit should arrive on site clean, even if its most recent use has been on a non-asbestos job. The unit should contain a copy of the clearance certificate from the most recent asbestos removal job. The certificate should be attached in a prominent position in the clean end.

Figure 8.2 Hygiene unit directly attached to the enclosure

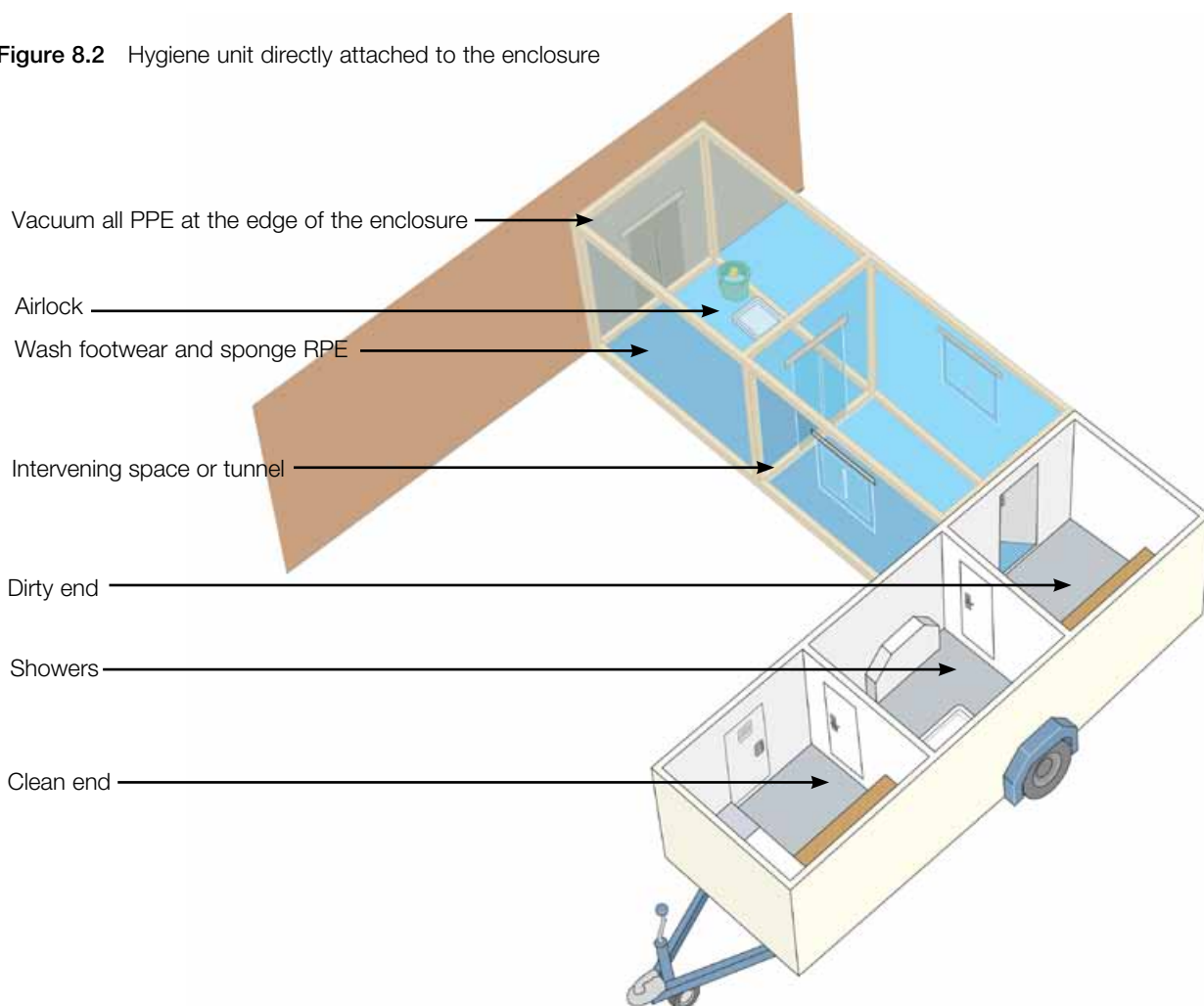

8.5 The purpose of going through decontamination procedures is to ensure that any asbestos fibres or debris are removed from the person and their PPE and RPE to prevent the spread of contamination outside the work areas. Decontamination to prevent the spread of fibres is important not only for the asbestos removal workers, but also for others who come into contact with them, eg their families or other workers in the vicinity of the enclosure. Family members can be exposed to asbestos if contaminated clothing is taken home.

Effective and thorough decontamination is important for asbestos removal workers, their families and others on the site

What does the decontamination process involve?

8.6 The exact entry and decontamination procedures will depend on the layout of the site and, in particular, on whether the hygiene unit is directly attached to the enclosure (described as 'non-transiting') or is remote from the enclosure ('transiting'). The procedures are covered in paragraphs 8.8-8.11 and 8.12-8.17 respectively. The former arrangement (ie a hygiene unit directly attached to the enclosure) is desirable and preferable as it reduces the potential for asbestos to spread outside the enclosure, and the decontamination procedures are much simpler and shorter. Transiting should only be employed where it is not reasonably practicable to attach the unit to the enclosure.

8.7 The decontamination procedures are set out in five flow charts (Figures 8.8-8.12). These describe the respective enclosure entry and exit procedures for non-transiting and transiting, as well as the procedures for washing and decontaminating inside the DCU.

The flow charts are as follows:

- Figure 8.8: Decontamination process: Hygiene unit attached to the enclosure: Entering enclosure
- Figure 8.9: Decontamination process: Hygiene unit attached to the enclosure: Leaving enclosure
- Figure 8.10: Decontamination process: Transiting procedure: Entering enclosure with new work coveralls
- Figure 8.11: Decontamination process: Transiting procedure: Entering enclosure after break
- Figure 8.12: Decontamination process: Transiting procedure: Leaving enclosure

Hygiene unit connected to enclosure

8.8 The hygiene unit is attached to the enclosure. This type of decontamination procedure is outlined in Figures 8.8 and 8.9. The positioning of the hygiene unit should be considered when first assessing the job and drawing up a suitable method statement.

8.9 The hygiene unit (mobile or modular) should be connected to the enclosure through a short intervening space or tunnel and a one-stage airlock constructed of polythene sheeting (see Figure 8.2). DCUs should never be directly attached to the enclosure without the intervening space as research suggests that contaminated air may be drawn in from the enclosure into the dirty end of the DCU (see the HSL report *Investigation into the effectiveness of modular hygiene units*).³⁵ The intervening space is there to provide an air gap between the enclosure and the DCU and it must be fitted with a vent to the open air. The vent openings should be constructed in a similar manner to the enclosures' access openings (ie slits with weighted flaps, see Figure 8.2) but should be smaller as they must not be used for entry or exit.

8.10 This method of linking the DCU to the enclosure should be normal practice

unless it is impracticable to do so, eg due to limited space, restricted access or multi-storey work. Transiting procedures should be avoided where possible as there is a risk of spreading contamination along the transit route. The transit route will form part of the four-stage clearance test at the end of the job (see paragraph 7.102 on clearance procedures).

8.11 Waste should never be taken through the DCU as it could lead to gross contamination within the unit. Waste (and equipment) should be removed from the enclosure through a separate baglock (see Box 7.5).

Enclosures should always be directly connected to the enclosure, unless this is not reasonably practicable

Hygiene unit remote from the enclosure

8.12 Where it is not possible to attach the DCU directly to the enclosure, transiting arrangements will have to be employed. These procedures are longer and more complex than non-transiting. They involve the use of 'transiting' PPE and additional facilities to enable the worker to carry out preliminary decontamination before travelling to the DCU for full decontamination. The process is described in Figures 8.10-8.12.

Figure 8.3 Transit facilities (ie three-stage airlock)

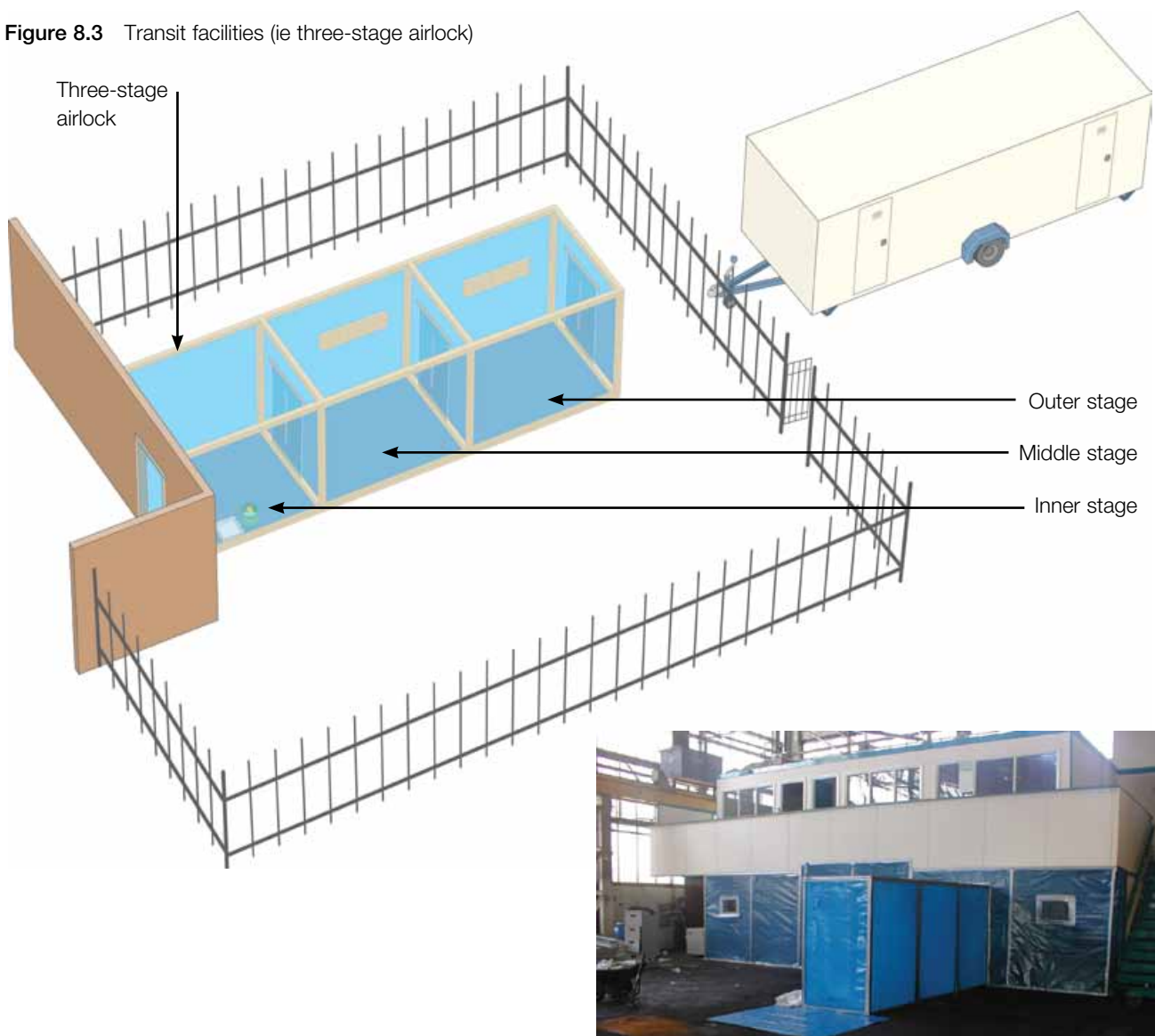

8.13 Transit facilities (also known as the three-stage airlock) should be specially constructed and made of polythene sheeting. They should be attached to the stripping enclosure and should comprise of three compartments separated by weighted sheets to minimise the spread of dust between the compartments. As shown in Figure 8.3, the inner stage is the compartment nearest to the enclosure, the middle stage is the middle compartment and outer stage is the last compartment that operatives will go through before walking to the DCU. The three-stage airlock should be as big as possible to enable the workers to change and decontaminate. The absolute minimum dimensions for each compartment should be 1 m x 1 m x 2 m. Where space is unrestricted, these compartments should be larger.

Airlocks should have minimum internal dimensions for each compartment of 1 m (width) x 1 m (depth) x 2 m (height)

8.14 The three stages should have the following facilities within them:

Outer stage: Facilities to store transit overalls and footwear, eg hooks and/or shoe-holders.

Middle stage: Facilities to store overalls and footwear worn in the enclosure, eg hooks and/or shoe-holders.

Inner stage: Footbath and brush, water bucket and sponge or wipes for RPE. (Type H vacuum cleaner is usually located at the edge of the enclosure).

8.15 The transit procedure is designed to ensure that the potential for spread of asbestos fibres from 'used' work PPE during transiting is minimised. On leaving the enclosure, all contaminated items (ie coveralls, footwear and RPE) should be cleaned, and coveralls and footwear should be replaced or covered. Transit coveralls (normally a distinct and different colour to work coveralls) and footwear should be worn travelling to and returning from the enclosure. Used work coveralls should be removed in the middle stage of the airlock and either disposed of as hazardous waste or stored for reuse, eg after meal breaks. Used work footwear may be stored after use (in the middle stage) or covered with 'overshoes' during transiting. New (ie unused and clean) work coveralls should be worn under transiting coveralls en route to the enclosure.

8.16 All transit routes should be delineated to ensure that other workers or members of the public keep away from this route, where practicable. Any contamination found on the transit route at clearance stage will delay the issuing of a certificate of reoccupation to the client.

8.17 In a few exceptional circumstances the normal travelling procedures described above may not be appropriate. There may be some circumstances where wearing a full-facepiece respirator causes increased health and safety risks such as trips and falls, eg if transiting at height or through heavy industrial plant. This type of situation is foreseeable and alternative arrangements can be put into place. In such circumstances, the full-facepiece respirator may be removed in the middle stage of the transit facility after primary decontamination and replaced with a FFP3 disposable face mask. The worker can then travel to the DCU wearing the disposable mask and carrying the full-facepiece respirator.

The relevant decontamination procedure should be followed each time a worker leaves the enclosure

Figure 8.4 Mobile facilities



Training in decontamination procedures

8.18 Chapter 4 on training specifies the topics that must be covered by asbestos removal operatives. It is essential that workers receive practical training on decontamination procedures to acquire the knowledge and skills necessary to decontaminate properly. Training should involve practising how to decontaminate in a simulated environment. It is particularly important for workers to recognise the need for primary decontamination during transit procedures.

Monitoring of the decontamination process

8.19 Supervisors play a key role in the day-to-day monitoring and checking of all procedures, including decontamination. It is essential that operatives decontaminate thoroughly each time that they leave the work area, no matter how short the time spent inside the enclosure. Supervisors should monitor compliance with decontamination procedures (frequency and duration) to ensure that workers do not develop poor practices or become complacent. In addition, supervisors should ensure that no inappropriate items are taken into the hygiene unit, eg filled waste bags, lemonade bottles etc.

Figure 8.5 Modular facilities



Final decontamination should be carried out, irrespective of the time spent inside the enclosure

8.20 Where operatives are found not following the decontamination procedures, consider retraining and/or the instigation of internal disciplinary procedures. Incomplete or ineffective decontamination is a very serious matter and may cause asbestos exposure for the individual, colleagues, other workers and even family members (see paragraph 8.5).

Emergency procedures

8.21 Arrangements should be made for suitable emergency procedures to be implemented in the event of loss of services to the DCU. Contingency plans should be developed for alternative basic decontamination procedures using other facilities on site or by organising the services of another DCU. These arrangements should be clearly formulated so that workers and supervisors are aware of the actions to take.

Figure 8.6 Vehicle type



DCUs

The different types of DCU

8.22 There are various types of DCUs used by contractors. The common types are 'mobile' and 'modular' facilities (see Figures 8.4 and 8.5 respectively). In addition 'vehicle type' DCUs have been developed in recent years and are becoming more popular, particularly on short-duration jobs (eg soffit removal) and on sites where security is an issue (see Figure 8.6). Historically, other types of DCUs have also been used (eg 'fixed' types such as converted welfare facilities). The minimum design criteria for different types of unit are given in Appendix 8.1.

8.23 Hygiene units should be purpose-built and should only be used for the decontamination of asbestos workers. Additional welfare facilities such as toilets and canteen facilities will be required to satisfy regulation 22 of the Construction (Health, Safety and Welfare) Regulations 1996³⁶ (see also *Provision of welfare facilities at fixed construction sites*).³⁷ Hygiene units should not be used as general welfare facilities.

It is unlikely that a converted caravan or construction site welfare hut would be capable of meeting the design criteria listed in Appendix 8.1

Mobile units

8.24 For the purposes of this guidance, a mobile unit is a caravan-style or re-locatable self-contained unit that can be towed to the site. This type of unit should be used in preference to modular units, as they are generally larger and therefore provide more space and comfort for thorough decontamination. They are usually available in several sizes to accommodate 2-8 people.

Modular units

8.25 Modular hygiene units are panel-based systems which enable rapid construction of the facilities on site. The panels reduce the space required for storage and transportation. Some modular units can be assembled in different configurations (eg straight line or L-shape) or be extended to more than three compartments. The air extraction unit, the water management system and the electrical/sockets system are usually positioned outside the hygiene facility.

8.26 The use of such units can avoid the need for transiting and mean that the facility can be attached to the enclosure (via an intervening space, see paragraph 8.9). There are potential disadvantages with modular units, particularly size, integrity, and the effectiveness of the water management systems. Any modular units that do not meet the criteria in Appendix 8.1 should not be used for asbestos removal decontamination work.

Vehicle units

8.27 This is a relatively new design of unit. It is a self-contained, fully independent unit that can be driven directly to the site. Its mobility and flexibility offer benefits for certain jobs and situations, eg short duration jobs (soffits) and sites where security is an issue. The vehicle is usually designed to contain a storage section as well as the DCU. Size may be an issue for this type of unit. It should meet the criteria in Appendix 8.1.

The reasons for using modular units should be clearly set out in the RA and method statement for the job

Connections to services

Electrical services

8.28 For the purpose of specifying the electrical systems, a DCU should be treated in the same way as a caravan. The applicable technical standard for the power distribution system in the unit is BS 7671:2001,³⁸ with Section 608 Division 1 providing specific requirements relating to installations in caravan-like structures such as a DCU, and with Section 601 being applicable to the electrical systems in the shower area of the DCU.

8.29 The supplies to the DCU may be drawn from a fixed installation or from a generator and will typically be single phase 230 volts. Units may operate at 110 volts, commonly supplied from a transformer with its secondary windings centre-tapped to earth, although there is no specific requirement for the use of reduced extra low voltage supplies in this particular application. If the intention is to supply the DCU from a generator provided by the user, it will be necessary to check that the voltage, power rating, earthing and referencing, overcurrent and earth fault protection, isolation, and emergency stop features are suitable and appropriate for the application. If the generator is on hire, the hirer should provide full instructions on the safe use of the generator.

8.30 The electrical supply to the unit should be configured as a TN-S or TT system, as defined in BS 7671:2001,³⁸ and should not be TN-C-S (also known as combined neutral/earth or protective multiple earthing).

8.31 Protection against indirect contact electrical injury should normally be provided by earthed equipotential bonding and automatic disconnection of supply. In addition to protection against excess current, the installation should have a residual current protective device, such as an RCD, fitted in the main consumer unit or distribution board. The rated residual operating current of the device should not exceed 30 milliamps and the device should trip within 40 milliseconds for a residual current of 150 millamps. In those circumstances where the residual current device is on the supply to lighting circuits, consideration should be given to fitting emergency lighting in the unit to provide illumination in the event of the supply tripping.

8.32 Before first use, the electrical systems should be inspected and tested by a competent person to verify compliance with the standards. The requirements for initial verification of the power distribution systems are described in Section 2 of the Institution of Electrical Engineers (IEE) guidance note *Inspection and Testing*.³⁹ Electrical equipment used in the DCU should be inspected and tested in accordance with the guidance in the IEE's *Code of Practice for In-service Inspection and Testing of Electrical Equipment*.⁴⁰

8.33 When delivered to site, checks should be made to ensure that the power supply is compatible with the DCU. If the intention is to use a power socket outlet in the user's premises, the earthing configuration and the voltage, polarity and earth fault loop impedance at the socket outlet should be checked to ensure that they are suitable for the application. This will normally need to be done by a competent person with specialised skills and knowledge, such as an electrician.

Gas appliances

8.34 The gas (normally liquid petroleum gas (LPG)) system needs to be checked to ensure that it is operating safely. The gas pipework connections and boiler can be damaged during transportation and use. Therefore, the LPG system and boiler should be inspected daily and at the end of a contract (hire) and before the next use of the DCU.

Water supply and wastewater

8.35 Ensure that the water and wastewater supplies are insulated against frost damage. All piping should have flexible jointing to prevent rupture. Wastewater should be filtered through a high efficiency filter (specification less than 5 microns). It is essential to check that there is sufficient water pressure and hot water.

Figure 8.7 Notices on DCU



Provision of information

8.36 Notices on and in the hygiene unit can prevent misunderstanding and continually warn people of hazards. Notices should be fixed at each entrance door, clearly indicating which is the clean and which is the dirty end and prohibiting unauthorised entry (see Figure 8.7). Drainage pipes and electrical connections should be labelled.

Maintenance and cleaning of hygiene facilities

Inspection and cleaning

8.37 Debris should not be allowed to accumulate and enclosure waste bags should never be allowed to pass through the DCU. Hygiene facilities should be cleaned at the end of each working day. This should include vacuuming and a thorough washing down of all exposed surfaces. The filled waste bags in the shower and dirty end should be removed (stocks of waste bags and NPU pre-filters should be retained in the shower compartment and dirty end, as appropriate). People carrying out cleaning should wear protective clothing and RPE and should work from the clean end towards the dirty end. Waste bags from the shower and dirty end (properly cleaned, labelled and double bagged) should be removed via the dirty end.

8.38 Before leaving the site, the water systems should be drained, traps in the shower and washbasin waste should be emptied and residues placed in a plastic bag for disposal as asbestos waste. Any transit route and the area where the facility has been parked should be inspected and cleaned as necessary, to ensure that there is no residual asbestos waste.

8.39 At the end of the asbestos job, the hygiene facility should be thoroughly cleaned and then subjected to a clearance test. Full details on this are given in paragraphs 7.146-7.148. On successful completion of the test, a clearance certificate should be posted in the clean end of the unit before it is used for the next job. Where the DCU is removed from site at the end of the working day for security reasons, it should be locked and treated as being contaminated. It should be returned to as close to the previous location as possible.

Maintenance

8.40 The DCU should be kept in an efficient state, efficient working order and in good repair. A list of daily and weekly checks, to be carried out by a supervisor, can be found in Box 8.1. In addition, the unit should be maintained in accordance with the manufacturer's instructions. If there are problems with any of the following: shower, heating, extraction and battery-charging facilities, the unit should not be used until a replacement item has been made available, or the fault has been remedied.

If there are problems with the shower, heating, extraction or battery-charging facilities, the unit should not be used

Thorough examination and testing

8.41 The following equipment should be examined and tested by a competent person and a record kept:

- Air extraction system (every six months): including DOP or sodium chloride tests on the HEPA filter and a check on the volumetric flow rates.
- Gas appliances: should be serviced and maintained in accordance with the manufacturer's recommendations. Gas fitters should be competent and have received training accredited by UKAS.
- Electrical systems: Electrical systems in the DCU should be maintained in accordance with the IEE guidance note³⁹ on Inspection and Testing (for the distribution system) and the IEE's *Code of Practice for In-service Inspection and Testing of Electrical Equipment*⁴⁰ (for the electrical equipment including portable appliances).

- Electrical systems should be routinely checked. Checks should include:
 - a visual inspection for evidence of breakages, wear/deterioration, signs of overheating, missing parts (eg screws, covers), switchgear accessible (ie not obstructed), secure doors, adequate labelling, loose fittings;
 - operation of the equipment, ie equipment is working: lighting, heating, shower unit, RCDs (using test button), sockets, switchgear (where reasonable).
- The routine checks should be undertaken by a competent person on a weekly basis and a formal recorded check should be made monthly. The RCDs providing automatic disconnection on the distribution circuits should be tested on a daily basis. The routine checks should embrace all the electrical equipment in the DCU. The competent person selected to do this work does not need to be an electrician but should be someone who has been trained on what to look for and who can be relied upon to do the job in a thorough manner.
- Electrical equipment (including portable equipment) installed or used in the DCU should also be inspected and tested in accordance with the IEE Code of Practice.⁴⁰ The in-service combined inspection and test should be performed before the DCU is delivered to site. For the power distribution system the tests should include a combination of continuity, insulation resistance and functional tests as described in the IEE guidance note.³⁹
- When the DCU remains on site or in continual use for extended periods, subsequent combined inspection and tests should be carried out every three months in line with the requirements for installations on construction sites.³⁸ The tests do not need to be as extensive as the initial test but should include continuity (of the circuit protective conductors, and the main supplementary bonding connections), earth fault loop impedance tests, and functional tests.
- Combined inspection and testing should be undertaken by a competent person (normally a qualified electrician for work on the power distribution system).

Record-keeping

8.42 Records should be kept of site inspections as well as thorough examinations and tests. Thorough examination and test records should be kept for five years and copies of the most recent tests should be available for inspection on site.

Box 8.1 Supervisors' checklist for asbestos hygiene units

Pre-use checks

Visual check of electrical equipment for obvious defects:

- compatibility of electrical power sources;
- an earth fault loop impedance test;
- the voltage and plug pins of electrical equipment are compatible;
- when modular hygiene units are installed on site the earth bonding should be checked.

Daily checks

The following daily operational checks should be carried out by a suitably trained supervisor before the beginning of each shift:

- adequate supplies of water, gas and electricity;
- adequate shower pressure and temperature;
- operation of heating system;
- operation of NPU, including checking the pressure gauge/warning device to ensure that the HEPA filter has not become saturated;
- functioning battery chargers;
- provision of sufficient waste bags, towels (one set in the shower area and one in the 'clean' end), filters and PPE;
- cleanliness of unit and transit route and facilities;
- operation of vacuum cleaner; supply of sponges and water baths in any transit airlock provided;
- the integrity of airlocks;
- environmental conditions that may affect the use of the DCU facilities, eg frozen pipes;
- testing of RCDs.

Weekly checks

Visual check of electrical equipment for damage, wear, overheating etc.

Showering and laundering

Laundering of coveralls and towels

Coveralls

8.43 Coveralls used during asbestos work should be treated as contaminated and therefore must either be disposed of as asbestos waste, or bagged up for washing at a 'specialist' laundry, ie a laundry which has the facilities and expertise to launder asbestos-contaminated items. Contaminated coveralls must never be taken home.

Towels

8.44 HSE research has demonstrated that there is the potential for towels used by asbestos workers to become contaminated (*Investigation into the effective laundering of towels and coveralls used for asbestos work*).⁴¹ The contamination of the towels suggests that workers or their RPE are not being fully or effectively decontaminated, or that towels have been used to clean surfaces.

8.45 Contaminated towels have the potential to cause further spread and exposure and therefore there are implications for subsequent towel handling and laundering. Procedures for laundries which handle asbestos-contaminated items are set out in paragraph 8.47. In addition, asbestos contractors must have a policy

and procedures for towel use. Guidance on this is set out in Box 8.2. Contractors must however ensure that their workers carry out full and effective decontamination (including their RPE) in the shower every time.

Never take home towels used beyond the clean end of the hygiene facility

8.46 Contaminated towels should be bagged and laundered separately from contaminated coveralls.

Laundry operators

8.47 Laundry operators (ie independent specialist commercial laundries and 'in-house' laundries operated by asbestos removal companies) should assess the potential risks from laundering asbestos-contaminated clothing and towels (both before and after laundering) and, to prevent exposure and spread of asbestos, should:

- provide a clearly defined, lockable room(s) containing the washing and drying machines dedicated for dealing with asbestos-contaminated laundry only;
- limit access to these facilities to a minimum number of trained and equipped personnel;
- provide good mechanical air extraction (negative pressure with HEPA filtration) in the room(s);
- equip employees loading the washing machine(s) with appropriate RPE;
- operate high standards of hygiene;
- use separate wash cycles for heavily and lightly contaminated items;
- use separate wash cycles for towels and coveralls;
- filter waste water and subsequently treat the filter(s) as contaminated asbestos waste;
- discharge air from tumble drier(s) to the external atmosphere;
- conduct regular air monitoring and record the results.

Box 8.2 Showering procedures and the use of towels

On returning to the DCU, all workers should shower thoroughly and properly by taking sufficient time (a minimum of five minutes), care and attention. In particular, hair should be thoroughly washed and fingernails should be thoroughly scrubbed.

After thorough decontamination in the shower cubicle, the next step is to ensure that employees follow the company's system for the use of towels for drying. There are two options which employers can use:

- drying in the shower cubicle;
- drying in the clean end of the DCU.

Employers must decide which of these options to use – they cannot mix both. Irrespective of which option is used, employers need to ensure that their employees follow the system by instructing them in the procedures, monitoring their compliance and by taking remedial action as necessary.

Drying in the shower cubicle

Having thoroughly showered, employees should:

- dry themselves as thoroughly as possible while still in the shower cubicle, including their feet and toes;
- treat the towel used in the shower cubicle as contaminated and either dispose of it as asbestos waste or bag it up for washing at the specialist laundry;
- if necessary, finish off drying in the clean end of the DCU, using a fresh towel, which if it has never progressed beyond the clean end of the DCU, can be deemed to be uncontaminated.

Drying in the clean end of the DCU only

Having thoroughly showered, employees should:

- step into the clean end of the DCU and using a clean towel (ie one that has never progressed beyond the clean end), carry out the entire drying process there;
- treat the towel as uncontaminated and either dispose of it as non-asbestos waste or bag it up for washing with normal laundry (taking care not to cross contaminate with any asbestos-contaminated laundry), using the employer's systems.

Employers using the second option will need a system to test that towels used solely in the clean end of the DCU have not become contaminated. It is suggested that periodic testing (eg 5% of jobs) is carried out, using a suitable method, to check for asbestos contamination on towels. The findings should be recorded.

APPENDIX 8.1: MINIMUM DESIGN CRITERIA FOR ASBESTOS HYGIENE UNITS

A8.1.1 The criteria listed below apply to mobile and modular units, unless otherwise stated. Mobile units offer more space to decontaminate properly. A modular unit should only be used where space does not permit the use of a mobile unit and where its use removes the need for transit procedures. The same design criteria should also be used in the construction of vehicle-type hygiene units.

If a DCU is used that does not meet these criteria, enforcing authority inspectors may consider the unit to be unsuitable for asbestos decontamination and prohibit its use

A8.1.2 The following criteria for hygiene units have been compiled after consultation with known suppliers and manufacturers of hygiene units. The list also incorporates recommendations from a Health and Safety Laboratory report, *Investigation into the effectiveness of modular hygiene units*,³⁵ which examined the standards for modular hygiene units.

Design and general construction

A8.1.3 Hygiene units should:

- be weatherproof or only be used inside a weatherproof building;
- be able to be made level on uneven ground;
- be robust enough not to distort when moved (racks are available for the storage of modular unit panels);
- have robust fixings that are not easily damaged in transport or use or dismantling (wing nuts and clips have been found to become easily damaged);
- be roadworthy (see National Trailer Towing Association guidance for trailed units);
- be of adequate size. Modular units should have minimum internal dimensions for each compartment of 1 m x 1 m x 2 m (height). Modular units should only be used by a maximum of two people at any one time. Mobile units are expected to be larger than modular units;
- have self-closing doors which should separate the three compartments ('clean', shower and 'dirty');
- have outward opening doors on the external access to the 'clean' and 'dirty' ends (self-closing at 'dirty' end);
- have internal surfaces that are impervious. Ledges and grooves should be avoided. The installation of windows should be avoided, but any windows provided should be non-opening, unbreakable and fitted flush with the inner wall. Units should be capable of being cleaned on site so that a clearance certificate can be issued showing the next user that the unit has been cleaned;
- be capable of being locked when not in use.

Heating and lighting

- Heating should be provided and heating appliances should be easy to clean.
- Units designed to be used inside buildings should be fitted with electrical water heating systems to avoid the need to vent combustion gases from gas appliances to the open air.
- Where gas appliances are fitted they should meet BS EN 1949:2002.⁴² All gas appliances should be installed by competent gas fitters who have received relevant training from a training body accredited by UKAS.
- LPG cylinders should be stored and transported in an external ventilated cupboard or rack that can be readily secured.
- Only room-sealed balanced flue-type gas heating appliances should be used.
- Adequate artificial lighting should provide, eg between 100-200 lux.
- Light fittings and other electrical appliances should be easy to clean and double insulated or permanently wired into the circuit and switched.

Services

- The electrical system should have earth bonding and an earth leakage circuit breaker.
- All electrical equipment should meet BS 7671:2001³⁸ and BS 6767:1998, Part 2.⁴³
- Connections to the water supply should have flexible joints. The supply should be protected against frost.
- Water filtration: wastewater should be filtered through a high efficiency filter (specification less than 5 microns).
- Hot water systems should be designed to avoid 'dead-legs', where legionella bacteria could grow.

Ventilation

- The unit should be ventilated. Air should be drawn in at the 'clean' end, pass through the shower and be discharged at the 'dirty' end (ie the NPU should be located in the 'dirty' end). A minimum of 30 air changes per hour should be achieved in the 'dirty' end.
- Grilles should be a minimum of 15 cm x 30 cm and pressure/gravity-operated flaps a minimum of 20 cm x 23 cm. However, it is the overall area of the grilles that affects the airflow, unless the louvres are at such a severe angle that they create turbulence. Better airflow will be achieved by having grilles on either side of the interior walls and by alternating from high to low level. External vents should be located as near to a central position as possible or have two symmetrical intakes. They should be provided with dust caps for transit.
- Air should be discharged via a HEPA filter or absolute filter and via a pre-filter.
- The extraction point should be placed low down in the 'dirty' end (or placed externally on modular units), but leaving enough room to clean beneath it, and positioned so that cleaning water does not damage it.
- A visible or audible warning device (such as a pressure gauge or warning light) should alert users to a failure of the NPU.

Facilities within compartments

- Lockers should only be used as seats in modular units where they are not in a position to block vents and air extraction points. Bench-type seating is preferred in addition to lockers.
- Showers: curtains should not be provided but a curtain rail should be provided above each shower on which to hang the operative's RPE battery pack etc while showering. One shower should be provided per four people. Hooks should be provided to hang up towels. Water pressure and flow should be regulated so that pressure does not drop when pumping water out of the unit or while using the wash-hand basin at the same time as one of the showers. The shower should have a thermostat, a shower rose, an outlet to the drain, a holder for soap or shower gel (use of gel helps to prevent the wastewater filter getting blocked), shampoo and nail brush etc and preferably have a shower tray.
- The 'clean' end: at least four hooks should be provided for hanging up clothing etc as well as a locker for each operative to store valuables. Battery-charging facilities (unless provided separately with a modular unit), a mirror and fixed seating (see first bullet point above) will be required. The 'clean end' needs to have the most space available for storage and dressing and undressing. Units can be designed to add on an extra unit or suitable changing area at this point to extend the facilities.
- The 'dirty' end: at least four hooks to hang RPE belts from while workers remove work or transit clothing and to hang up work or transit clothing. Sufficient space will be required to hold bagged waste filters etc. Fixed bench-type seating should be provided (see first bullet point above). A suitable wash-hand basin with plug and drainage point should be provided in either the shower area or 'dirty' end of the unit for washing dirty hands.

Maintenance

- All units should be maintained in 'an efficient state, in efficient working order and in good repair'. Hirers and users should be prepared to demonstrate how they maintain their equipment. Manufacturers and suppliers should provide information to buyers about how to maintain their units.

Information

- Notices: to indicate the 'clean' and 'dirty' ends and that unauthorised entry is prohibited. All drain outlets and electrical connections should be labelled to identify them.

Figure 8.8 Decontamination process: Hygiene unit attached to enclosure: Entering enclosure

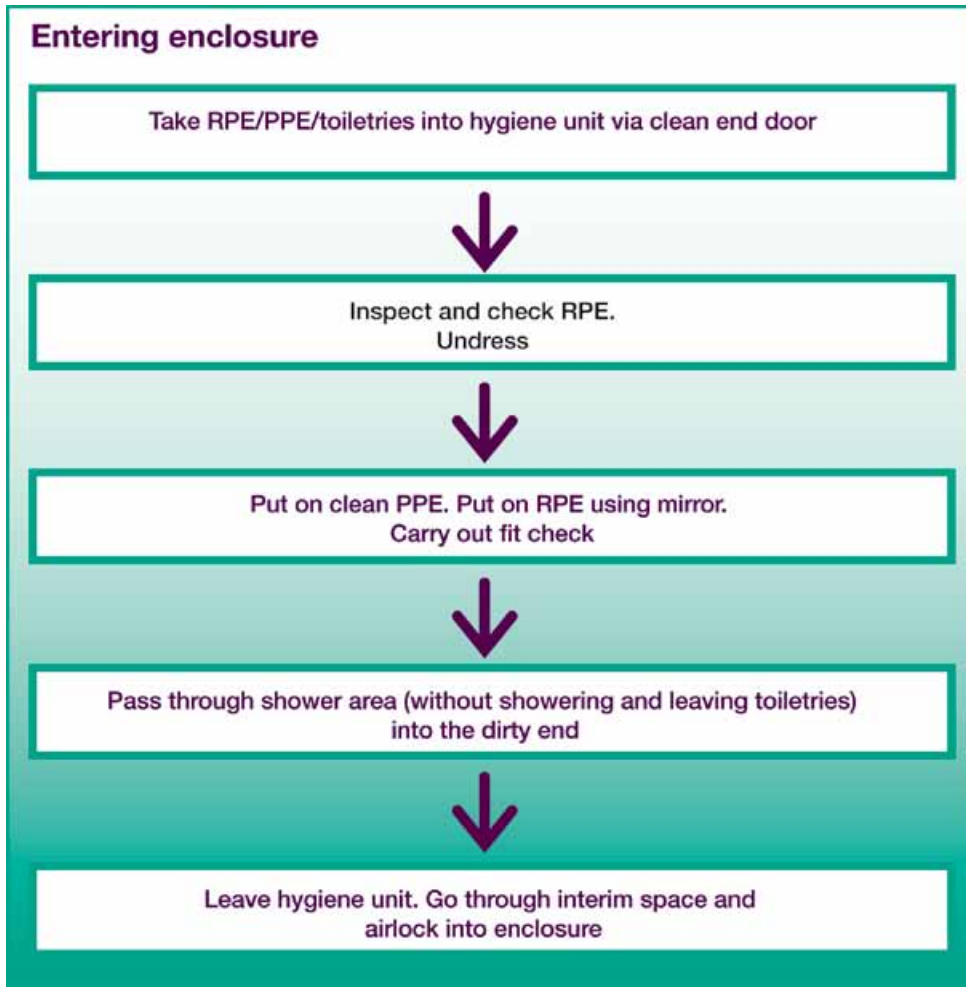

Figure 8.9 Decontamination process: Hygiene unit attached to enclosure: Leaving enclosure

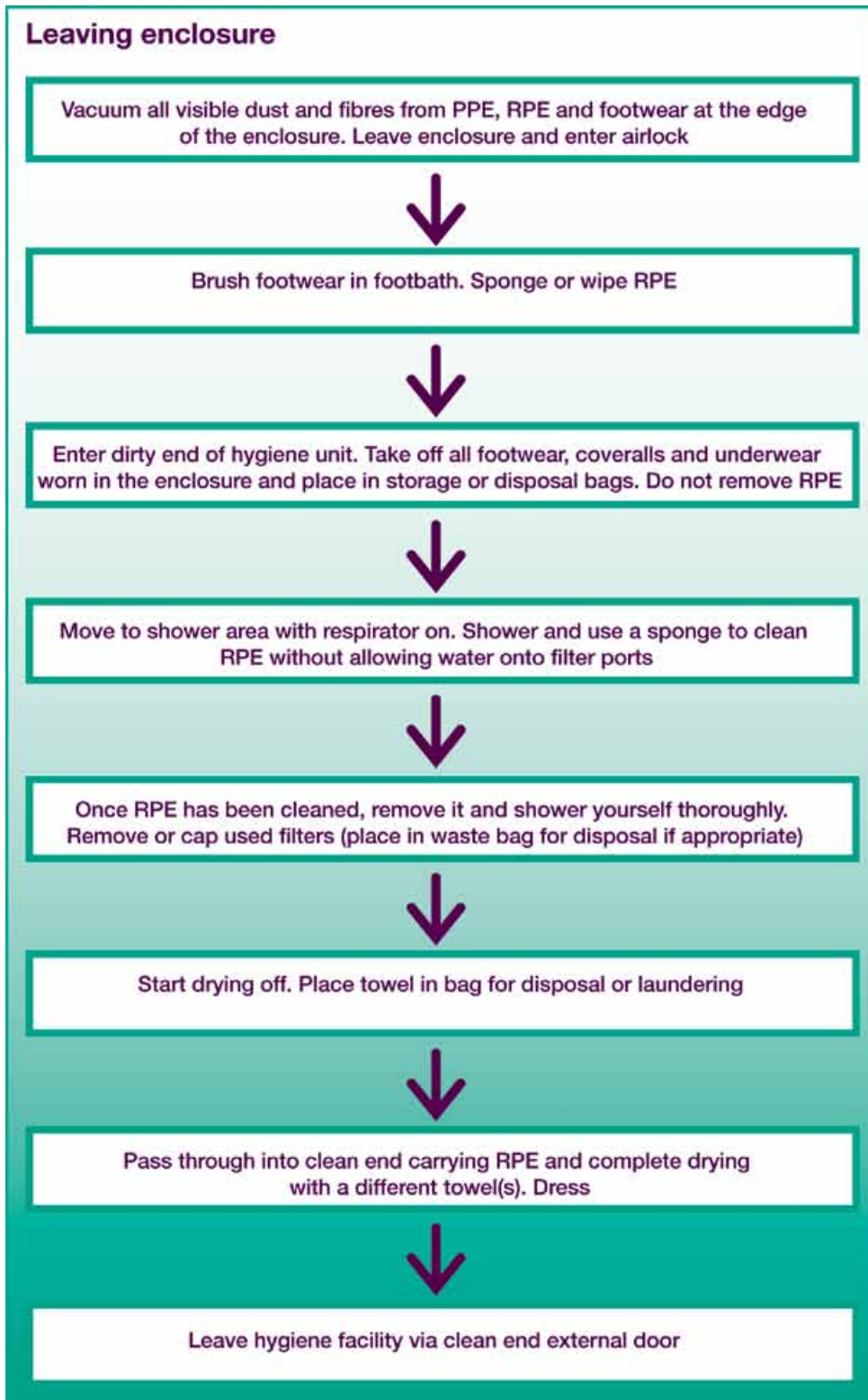

Figure 8.10 Decontamination process: Transiting procedure: Entering enclosure with new work coveralls

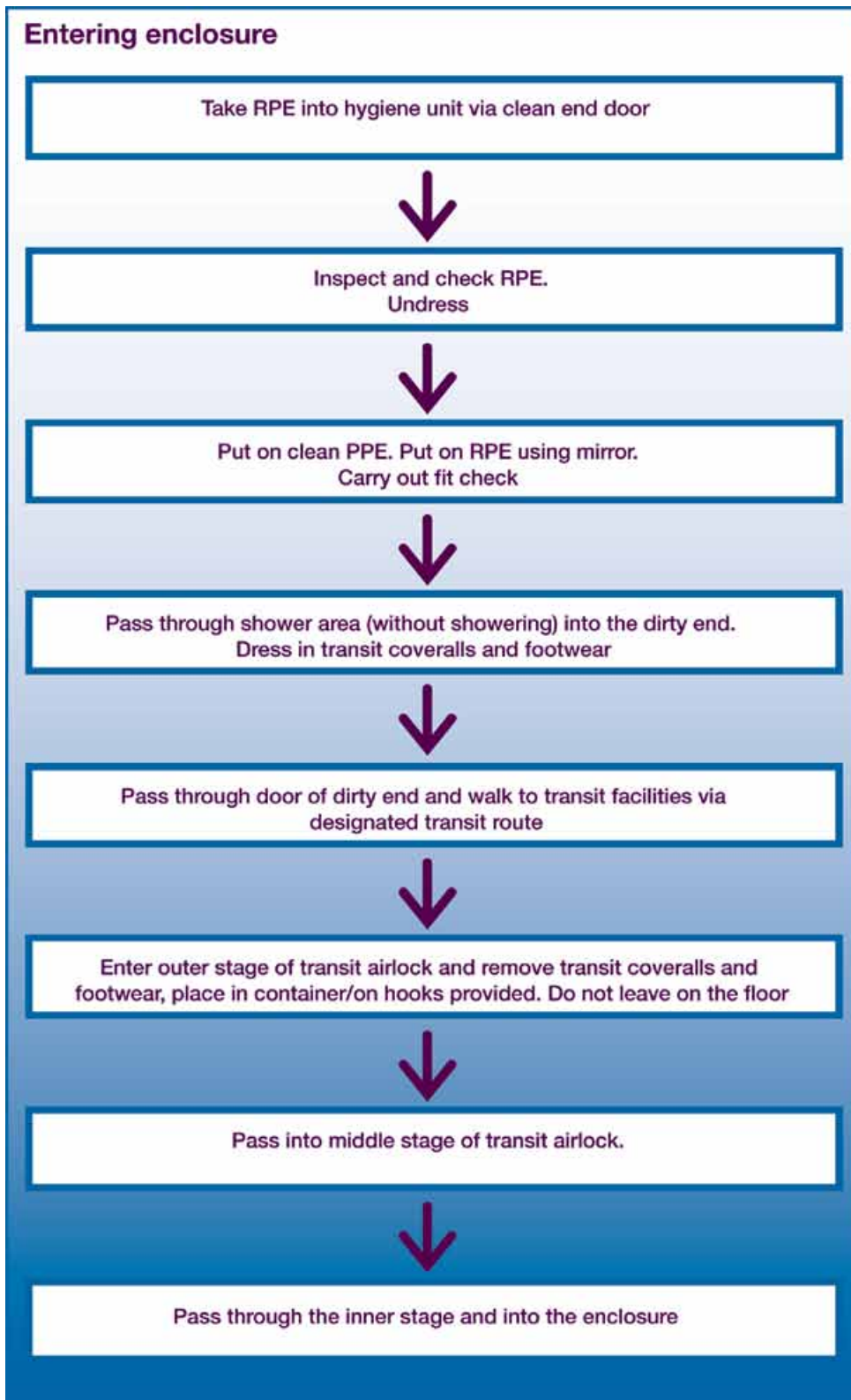

Figure 8.11 Decontamination process: Transiting procedure: Entering enclosure after break

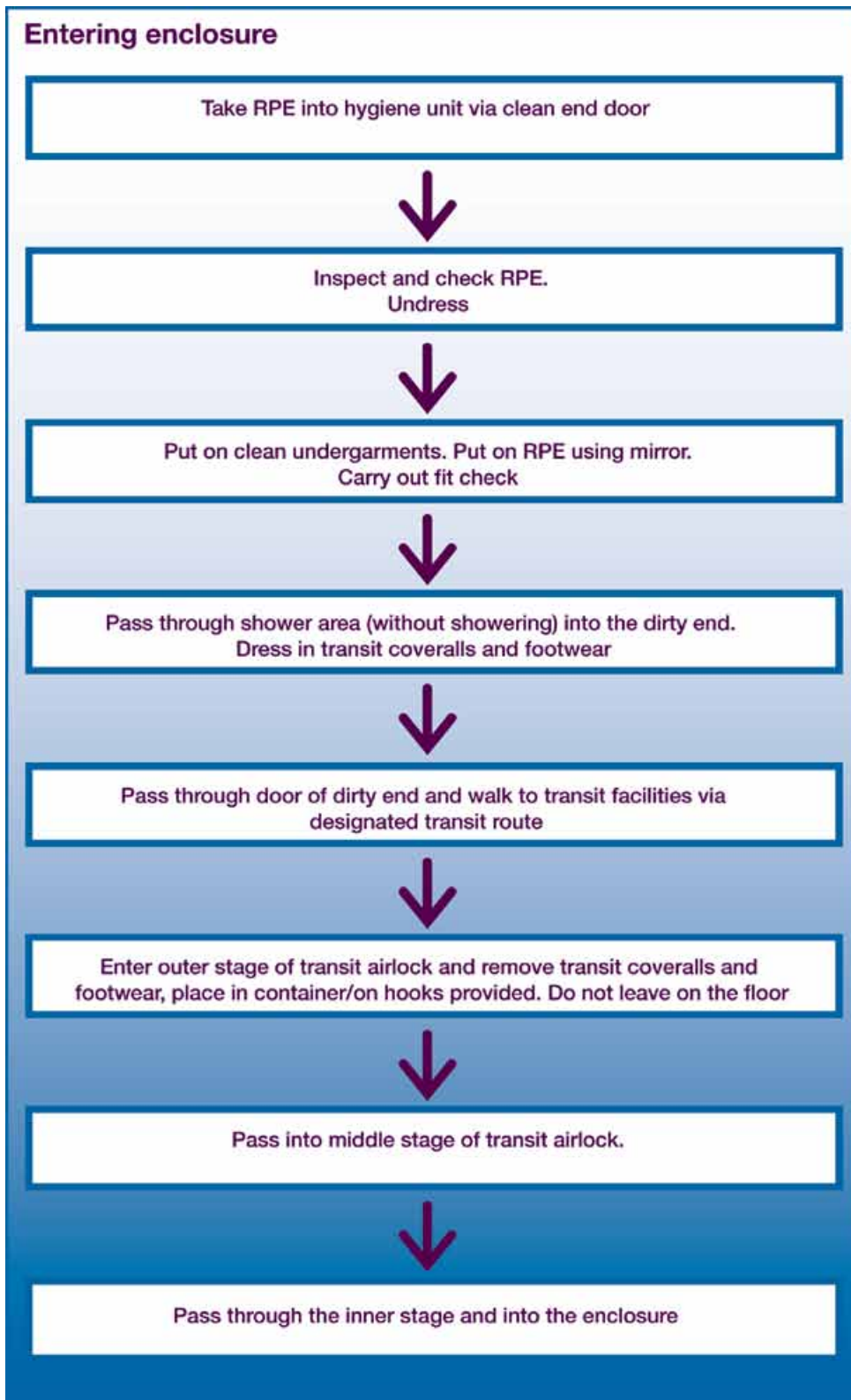
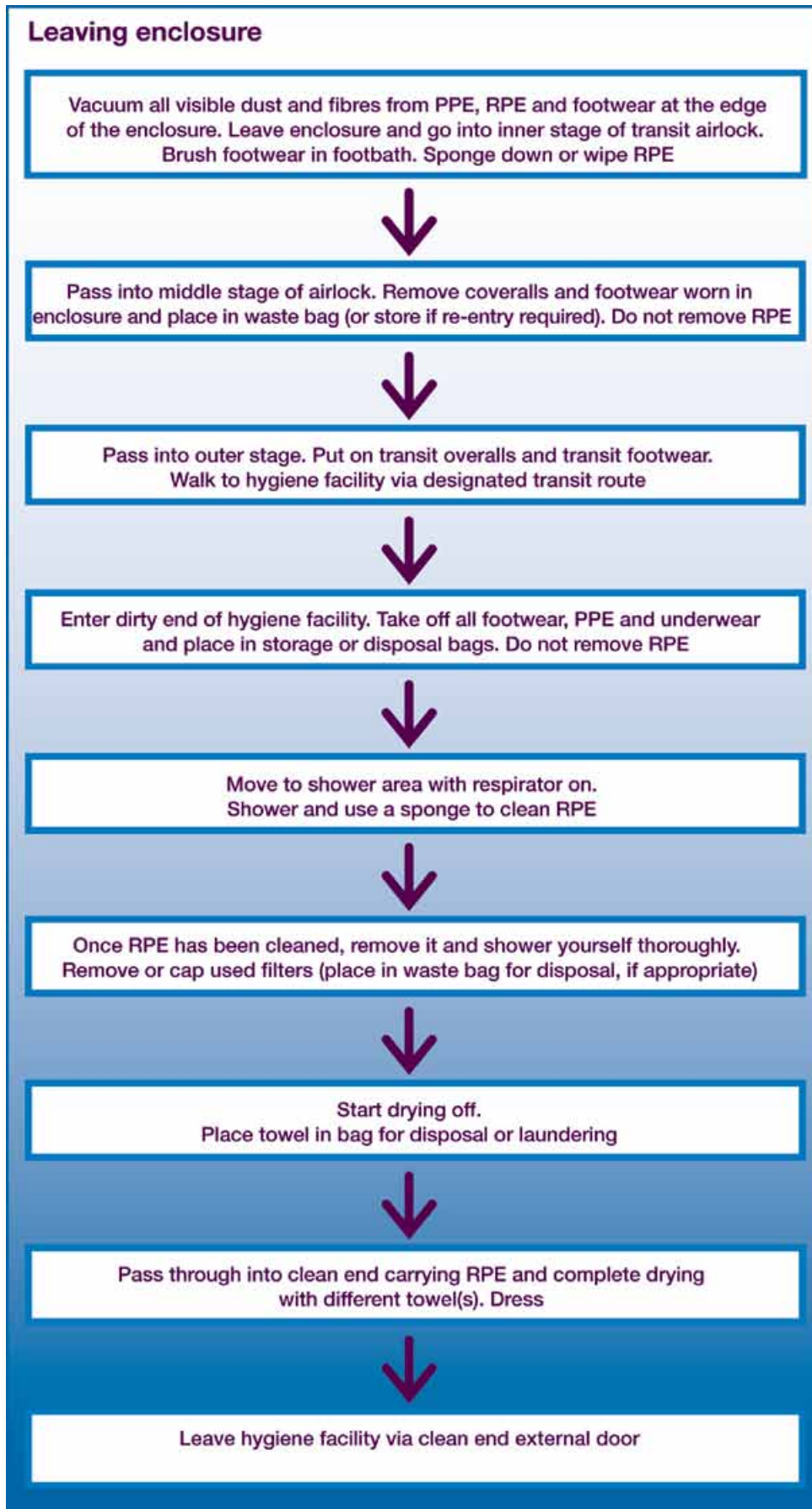

Figure 8.12 Decontamination process: Transiting procedure: Leaving enclosure



References and further information

- 1 *Asbestos (Licensing) Regulations 1983* SI 1983/1649 The Stationery Office 1983 ISBN 0 11 037649 8 as amended by the *Asbestos (Licensing) (Amendment) Regulations 1998* SI 1998/3233 The Stationery Office 1998 ISBN 0 11 080279 9
- 2 *Asbestos essentials task manual: Task guidance sheets for the building maintenance and allied trades* HSG210 HSE Books 2001 ISBN 0 7176 1887 0
- 3 *Working with asbestos cement* HSG189/2 HSE Books 1999 ISBN 0 7176 1667 3
- 4 *Safety Representatives and Safety Committees Regulations 1977* SI 1977/500 The Stationery Office 1977 ISBN 0 11 070500 9
- 5 *Health and Safety (Consultation with Employees) Regulations 1996* SI 1996/1513 The Stationery Office 1996 ISBN 0 11 054839 6
- 6 *Consulting employees on health and safety: A guide to the law* Leaflet INDG232 HSE Books 1996 (single copy free or priced packs of 15 ISBN 0 7176 1615 0)
- 7 *Control of Asbestos at Work Regulations 2002* SI 2002/2675 The Stationery Office 2002 ISBN 0 11 042918 4
- 8 *Asbestos: The analysts' guide for sampling, analysis and clearance procedures* HSG248 HSE Books 2005 ISBN 0 7176 2875 2
- 9 *Health and Safety at Work etc Act 1974 (c 37)* The Stationery Office 1974 ISBN 0 10 543774 3
- 10 *Management of health and safety at work. Management of Health and Safety at Work Regulations 1999. Approved Code of Practice and guidance L21 (Second edition)* HSE Books 2000 ISBN 0 7176 2488 9
- 11 *Managing health and safety in construction: Construction (Design and Management) Regulations 1994. Approved Code of Practice and guidance* HSG224 HSE Books 2001 ISBN 0 7176 2139 1
- 12 *Work with asbestos insulation, asbestos coating and asbestos insulating board. Control of Asbestos at Work Regulations 2002. Approved Code of Practice and guidance L28 (Fourth edition)* HSE Books 2002 ISBN 0 7176 2563 X
- 13 *Introduction to asbestos essentials: Comprehensive guidance on working with asbestos in the building maintenance and allied trades* HSG213 HSE Books 2001 ISBN 0 7176 1901 X
- 14 *A comprehensive guide to managing asbestos in premises* HSG227 HSE Books 2002 ISBN 0 7176 2381 5
- 15 *Safe work in confined spaces. Confined Spaces Regulations 1997. Approved Code of Practice, Regulations and guidance L101* HSE Books 1997 ISBN 0 7176 1405 0

- 16 *Control of substances hazardous to health (Fifth edition). The Control of Substances Hazardous to Health Regulations 2002 (as amended). Approved Code of Practice and guidance L5 (Fifth edition) HSE Books 2005 ISBN 0 7176 2981 3*
- 17 *Final report on the development of practical guidelines for the training of asbestos removal workers* Health and Safety Laboratory. Report for European Commission DGV under agreement number VG/1999/5190
- 18 *Review of training provided to asbestos removal workers 2002* Health and Safety Laboratory. Report no WPS/02/06
- 19 *Successful health and safety management HSG65 (Second edition) HSE Books 1997 ISBN 0 7176 1276 7*
- 20 *The Hazardous Waste (England and Wales) Regulations 2005 SI 2005/894* The Stationery Office 2005 ISBN 0 11 072685 5
- 21 *The Special Waste Amendment (Scotland) Regulations 2004* Scottish SI 2004/112 The Stationery Office 2004 ISBN 0 11 069030 3
- 22 *Environmental Protection Act 1990 (c 43)* The Stationery Office 1990 ISBN 0 10 544390 5
- 23 *Respiratory protective equipment at work: A practical guide HSG53 (Third edition) HSE Books 2005 ISBN 0 7176 2904 X*
- 24 *Fit testing of respiratory protective equipment facepieces* OC 282/28 HSE 2003
- 25 *BS EN 12021:1999 Respiratory protective devices. Compressed air for breathing apparatus* British Standards Institution 1999 ISBN 0 580 32082 0
- 26 *BS EN ISO 13982-1:2004 Protective clothing for use against solid particulates. Performance requirements for chemical protective clothing providing protection to the full body against airborne solid particulates (type 5 clothing)* British Standards Institution 2005 ISBN 0 580 46224 2
- 27 *Personal protective equipment at work (Second edition). Personal Protective Equipment at Work Regulations 1992. Guidance on Regulations 1992 (as amended) L25 (Second edition) HSE Books 2005 ISBN 0 7176 6139 3*
- 28 *General access scaffolds and ladders* Construction Information Sheet CIS49(rev1) HSE Books 2003
- 29 *Tower scaffolds* Construction Information Sheet CIS10(rev4) HSE Books 2005
- 30 *Health and safety in roof work HSG33 (Second edition) HSE Books 1998 ISBN 0 7176 1425 5*
- 31 *BS 5415-1:1985 Safety of electrical motor-operated industrial and commercial cleaning appliances. Specification for general requirements* British Standards Institution 1985 ISBN 0 580 14667 7
- 32 *Carriage of Dangerous Goods and Use of Transportable Pressure Equipment Regulations 2004* SI 2004/568 The Stationery Office 2004 ISBN 0 11 049063 0

- 33 *Are you involved in the carriage of dangerous goods by road or rail?* INDG234(rev) HSE Books 1999 (single copy free or priced packs of 10 ISBN 0 7176 1676 2)
- 34 BS EN ISO/IEC 17025:2005 *General requirements for the competence of testing and calibration laboratories* British Standards Institution 2005 ISBN 0 580 46330 3
- 35 *Investigation into the effectiveness of modular hygiene units* Report HSL/2001/16 Health and Safety Laboratory 2001
- 36 *A guide to the Construction (Health, Safety and Welfare) Regulations 1996* Leaflet INDG220 HSE Books 1996 (single copy free or priced packs of 10 ISBN 0 7176 1161 2)
- 37 *Provision of welfare facilities at fixed construction sites* Construction Information Sheet CIS18(rev1) HSE Books 1998
- 38 BS 7671:2001 *Requirements for electrical installations. IEE Wiring Regulations. Sixteenth edition* British Standards Institution 2001 ISBN 0 863 41373 0
- 39 *Inspection and Testing: Guidance Note 3 (for BS 7671:2001)* The Institution of Electrical Engineers 2002 ISBN 0 85296 991 0
- 40 *Code of Practice for In-service Inspection and Testing of Electrical Equipment* (Second edition) The Institution of Electrical Engineers 2001 ISBN 0 85296 776 4
- 41 *Investigation into the effective laundering of towels and coveralls used for asbestos work* Report HSL/2002/22 Health and Safety Laboratory 2002
- 42 BS EN 1949:2002 *Specification for the installation of LPG systems for habitation purposes in leisure accommodation vehicles and in other road vehicles* British Standards Institution 2002 ISBN 0 580 40404 8
- 43 BS 6767-2:1998 *Transportable accommodation units. Recommendations for design and installation of services and fittings with guidance on transportation, siting and aspects relating to habitation* British Standards Institution 1998 ISBN 0 580 29521 4

Further information

For information about health and safety ring HSE's Infoline Tel: 0845 345 0055
Fax: 0845 408 9566 Textphone: 0845 408 9577 e-mail: hse.infoline@natbrit.com or
write to HSE Information Services, Caerphilly Business Park, Caerphilly CF83 3GG.

HSE priced and free publications can be viewed online or ordered from
www.hse.gov.uk or contact HSE Books, PO Box 1999, Sudbury, Suffolk
CO10 2WA Tel: 01787 881165 Fax: 01787 313995. HSE priced publications
are also available from bookshops.

British Standards can be obtained in PDF or hard copy formats from the BSI online
shop: www.bsigroup.com/Shop or by contacting BSI Customer Services for hard
copies only Tel: 020 8996 9001 e-mail: cservices@bsigroup.com.

The Stationery Office publications are available from The Stationery Office,
PO Box 29, Norwich NR3 1GN Tel: 0870 600 5522 Fax: 0870 600 5533
e-mail: customer.services@tso.co.uk Website: www.tso.co.uk (They are also
available from bookshops.) Statutory Instruments can be viewed free of charge
at www.opsi.gov.uk.